

ORDER OF MANUFACTURING

- 1. POWER WIRING A-550-0-4
- 2. GROUNDS A-550-0-9
- 3. COMPONENTS LIST A-550-0-11
- 4. LOGIC WIRING A-550-0-2
- 5. TERMINATOR LIST A-550-0-6
- 6. CABLE LIST A-550-0-3

DRAWN
P.J. Priest 1-30-64
 CHECKED
D. Heath 3/27/64
 ENG
L. C. Woodford

digital
 EQUIPMENT
 CORPORATION
 MAYNARD, MASSACHUSETTS

TITLE
INDEX WIRING LIST

THIS SCHEMATIC IS FURNISHED ONLY FOR TEST
 & MAINTAINANCE PURPOSES. THE CIRCUITS ARE
 PROPRIETARY IN NATURE & SHOULD BE TREATED
 ACCORDINGLY.

App'v

FOR DEC TAPE CONTROL 550

DWG NO
A-550-0-1

REV. LTR.
A
 CODE
 WL

ECO. NO.
 REV. LTR.
A-2133

SHEET OF



EQUIPMENT CORPORATION
MAYNARD, MASSACHUSETTS

MASTER DRAWING LIST

CODE	DWG NO.	REV. LET.	NO. OF SHEETS	TITLE		
				PRODUCTION DWG'S (MECH)		
FPL	C-550-0-1	B	1	DEC - TAPE CONTROL 550		
PL	A-550-0-1	B	2	DEC - TAPE CONTROL 550 PARTS LIST		
MA	E-10800	B	1	1914 MTG PANEL		
PL	A-10800	B	2	1914 MTG PANEL PARTS LIST		
MD	C-01493	D	1	5 1/4 PLUG PANEL REWORKED		
MD	C-01492	C	1	COVER PLATE		
				PRODUCTION DWG'S ELEC		
MPL	A-550-0-5	E	1	MODULE PROCUREMENT LIST		
ML	A-550-0-10	E	1	MODULE LOCATION-MODULE JUMPERING		
S	A-550-0-7	C	1	SPECIAL WIRING INSTRUCTION		
MA	A-550-0-8	D	1	PANEL LAYOUT ASS'Y.		
CD	D-550-0-CD	B	1	DEC - TAPE 550 CONTROL INTERCONNECTING		
GD	GB 550 0 16		1	HEAD A CABLE		
GD	GB 550 0 17		1	SELECTION C CABLE		
GD	GB 550 0 18		1	SELECTION F CABLE		
GD	GB 550 0 19		1	HEAD B CABLE		
PW	D-550-0-PW	B	1	POWER WIRING & INDICATOR LITE WIRING		
GD	B 550 0 CD		1	INTERCONNECTING CABLES		
PL	A-550-0-CD	A	1	DEC TAPE 550 CONTROL INTERCONNECTING CABLES CHECKOUT & SERVICE DWG'S		
BD	D-550-0-BD	C	1	BLOCK DIAGRAM-550 CONTROL		
BS	D-550-0-C1	F	1	C1 CONTROL PRINT #1		
BE	D-550-0-C2	F	1	C2 FLAG RESPONSE DATA CONTROL OUTPUTS		
BS	D-550-0-TM	E	1	CONTROL PULSES		
BS	D-550-0-W	G	1	W MARK TRACK & DECODING ERRORS		
BS	E-550-0-IN	E	1	IN INFORMATION HANDLING		
UML	D-550-0-UML	F	1	UTILIZATION MODULE LIST		
TD	D-550-0-TD	C	1	TIMING DIAGRAM		
REV.	ECO	ENG	DATE	MADE BY 2/3/64 J. Lemoine P.J. Priest	CHECKER 2/19/64 D. Healy N. Rheault	ENG 2/19/64 L. Stockebrand
B	185	L.B.P.	2/19/64	TITLE		
C	RETPED	D.G.V.	5/1/64	FOR		
D	2054	D.G.V.	6/18/64	DEC TAPE CONTROL 550		
E	251		6/29/64	THIS SCHEMATIC IS FURNISHED ONLY FOR TEST & MAINTAINANCE PURPOSES; THE CIRCUITS ARE PROPRIETARY IN NATURE & SHOULD BE TREATED ACCORDINGLY.		
F	2123		8/25/64	NOV 4 1964		
H	281			CODE	DWG. NO.	REV
J	2133		9/17/64	MDL	A-550-0-1	
SHEET 1 OF 2						

digitalEQUIPMENT
CORPORATION
MAYNARD, MASSACHUSETTS**MASTER DRAWING LIST**

CODE	DWG NO.		REV. LET.	NO. OF SHEETS	TITLE	
CP	A-550-0-13		A	34	CHECKOUT PROCEDURE	
	A-550-0-01-13				BLOCK DIAGRAM	
					USER DOCUMENTS	
	PUBLICATIONS				DEC TAPE PAPER - L. HANTMAN	
	LIBRARY				DEC TAPE PROGRAM - 4, - 1	
	PUBLICATIONS				DEC TAPE SERVICE MANUAL	
MN	A-550-0-12		A	1	SPARE PARTS LIST	
WL	A-550-0-1		A	1	INDEX WIRING SHEET	
CL	A-550-0-3		D	9	I/O CONTROL	
PW	A-550-0-4		D	1	POWER WIRING	
TL	A-550-0-6		D	3	TERMINATOR LIST	
WS	A-550-0-9		D	4	GROUNDS	
CD	A-550-0-11		D	3	COMPONENTS LIST	
BWC	D-550-0-15		A	1	DEC TAPE 550 INSTALLATION (PDP-4)	
CL	A-550-01-00-04-00		B	1	TO INFO. PLUGS 550 CONTROL	
CL	A-550-01-00-05-00		B	1	TO CONTROL PLUGS 550 CONTROL	
WL	A-550-01-00-05-00		B	1	WIRING IN REAL TIME SECTION	
					THIS SCHEMATIC IS FURNISHED ONLY FOR TEST & MAINTAINANCE PURPOSES. THE CIRCUITS ARE PROPRIETARY IN NATURE & SHOULD BE TREATED ACCORDINGLY.	
REV.	ECO	ENG	DATE	MADE BY 2/3/64 J. Lemoine P. J. Priest	CHECKER 2/19/64 D. Healy N. Rheault	ENG 2/19/64 L. Stockebrand
B	L.S.P.	L.S.P.	2/23/64	TITLE		
C				DEC TAPE CONTROL 550		
				FOR <u>NOV 4 1964</u>		
SHEET 2 OF 2				CODE MDL	DWG. NO. A-550-0-1	REV. 1

digitalEQUIPMENT
CORPORATION
MAYNARD, MASSACHUSETTS**MASTER DRAWING LIST**

CODE	DWG. NO.	REV. LET.	NO. OF SHEETS	TITLE
				PRODUCTION DWG'S (MECH)
FPL	C-550-0-1	B	1	DEC - TAPE CONTROL 550
PL	A-550-0-1	B	2	DEC - TAPE CONTROL 550 PARTS LIST
MA	E-10800	B	1	1914 MTG PANEL
PL	A-10800	B	2	1914 MTG. PANEL PARTS LIST
MD	C-01493	D	1	5 1/4 PLUG PANEL REWORKED
MD	C-01492	C	1	COVER PLATE
				PRODUCTION DWG'S ELEC
MPL	A-550-0-5	E	1	MODULE PROCUREMENT LIST
ML	A-550-0-10	E	1	MODULE LOCATION-MODULE JUMPERING
S	A-550-0-7	C	1	SPECIAL WIRING INSTRUCTION
MA	A-550-0-8	D	1	PANEL LAYOUT ASS'Y.
WL	B-550-0-16			WIRE LIST TYPE 550 DT
CD	D-550-0-CD	B	1	DEC - TAPE 550 CONTROL INTERCONNECTING
PW	D-550-0-PW	B	1	POWER WIRING & INDICATOR LITE WIRING
PL	A-550-0-CD	A	1	DEC TAPE 550 CONTROL INTERCONNECTING CABLES CHECKOUT & SERVICE DWG'S
BD	D-550-0-BD	C	1	BLOCK DIAGRAM 550 CONTROL
BS	D-550-0-C1	H	1	C1 CONTROL PRINT #1
BS	D-550-0-C2	H	1	C2 FLAG RESPONSE DATA CONTROL OUTPUTS
BS	D-550-0-TM	F	1	CONTROL PULSES
BS	D-550-0-W	H	1	W MARK TRACK & DECODING ERRORS
BS	E-550-0-1N	F	1	1N INFORMATION HANDLING
UML	D-550-0-UML	H	1	UTILIZATION MODULE LIST
TD	D-550-0-TD	C	1	TIMING DIAGRAM

ISSUED

JAN 18 1965

REV.	ECO	ENG	DATE	MADE BY	CHECKER	ENG
B	185	L.B.P.	2/19/64	2/3/64 J. Lemoine	2/19/64 D. Healy	2/19/64 T. Stockebrand
C	RETYPED	D.G.V.	5/1/64	E. Massarelli	N. Rheault	
D	2054	D.G.V.	6/18/64	TITLE DEC TAPE CONTROL 550		
E	251	D.G.V.	6/29/64	FOR		
F	2123	J.E.S.	8/25/64			
H	281	J.E.S.				
J	2133	E.H.	9/17/64	SHEET <u>1</u> OF <u>2</u>	CODE MDL	DWG. NO. A-550-0-1
K	323	E.H.	12/29/64			REV. LET. K

digitalEQUIPMENT
CORPORATION
MAYNARD, MASSACHUSETTS**MASTER DRAWING LIST**

CODE	DWG. NO.	REV. LET.	NO. OF SHEETS	TITLE
CP	A-550-0-13	A	34	CHECKOUT PROCEDURE
BWC	D-550-0-15	A	1	DECTAPE 550 INSTALLATION (PDP-4)
BWC	D-20090 PUBLICATIONS		1	DECTAPE 550 INSTALLATION (PDP-1) DECTAPE SERVICE MANUAL
				USER DOCUMENTS
	PUBLICATIONS LIBRARY PUBLICATIONS			DEC TAPE PAPER L. HANTMAN DEC TAPE PROGRAM-4 ₂ - 1 DEC TAPE SERVICE MANUAL
MN	A-550-0-12	A	1	SPARE PARTS LIST

REV.	ECO	ENG	DATE	MADE BY 2/3/64 J. Lemoine E. Massarelli	CHECKER 2/19/64 D. Healy N. Rheault	ENG 2/19/64 T. Stockebrand
				TITLE DEC TAPE CONTROL 550		
				FOR		
				SHEET <u>2</u> OF <u>2</u>	CODE MDL	DWG. NO. A-550-0-1
						REV. LET. K

22	23	24	25	36	37	38	39	41	42	44	45	53	54	55	56	57	75	76	78	79	81
TITLE	A	P	RUN PIN	ORDER	COLOR VALUE	WIRE COMP	DWG LOCATION	CONT. KEY	S	REMARKS	PAGE	LINE									
D1										TP		50 PIN AMPHENOL	1	1							
DF + EF			D1-2			TWP						GRY/BLK	"	2							
"			ALM ROW 3			"						"	"	3							
MMRD			D1-4			"						"	"	4							
"			ALF ROW 3			"						"	"	5							
MMWR			D1-6			"						"	"	6							
"			ALF ROW 3			"						"	"	7							
						"						"	"	8							
						"						"	"	9							
LC + SE			D1-10			"						"	"	10							
"			ALK ROW 3			"						"	"	11							
M MDF			D1-12			"						"	"	12							
"			ALN ROW 3			"						"	"	13							
MMEF			D1-14			"						"	"	14							
"			ALL ROW 3			"						"	"	15							
POWER CLEAR			D1-16			"						"	"	16							
"			ALR ROW 3			"						"	"	17							
RUN			D1-19			"						"	"	18							
"			ALS ROW 3			"						"	"	19							
MMSE			D1-21			"						"	"	20							
A1			ALG ROW 3			"						REAR OF BLK	"	21							
MMLC			D1-23			"						"	"	22							
"			ALP ROW 3			"						REAR OF BLK	"	23							
MB			D1-25			"						"	"	24							
"			ALF ROW 1			"						"	"	25							

THIS SCHEMATIC IS FURNISHED ONLY FOR TEST & MAINTENANCE PURPOSES. THE CIRCUITS ARE PROPERTY OF THE AIR FORCE. NO REPRODUCTION OR TRANSMISSION IN ANY MANNER IS TO BE MADE WITHOUT AUTHORITY. NOV 4 1964

DRAFTSMAN <i>E. M. ... 1/23/64</i>		WIRING SEQUENCE	TITLE 10T CONTROL DECC TAPE 550 CONTROL	
CHECKED <i>H. ... 1/23/64</i>		CABLE LIST	ECO# IS D-2133 WAS C-201	DWG NO. A-550-0-3
ENGINEER <i>Thomas ... 1/24/64</i>				REV. LTR. D

TITLE	A	P	RUN PIN	ORDER	COLOR VALUE	WIRE COMP	DWG LOCATION	CONT. KEY	S	REMARKS	PAGE	LINE
DATA FLG ++			D1-26			TWP				GRY/BLK	2	1
"			ALT ROW 1			"				"	"	2
BLK FLG ++			D1-27			"				"	"	3
"			ALS ROW 1			"				"	"	4
ERROR FLG ++			D1-28			"				"	"	5
"			AIR ROW 1			"				"	"	6
OFFEND ++			D1-29			"				"	"	7
"			AIM ROW 1			"				"	"	8
MISS ++			D1-30			"				"	"	9
"			AIN ROW 1			"				"	"	10
REV ++			D1-31			"				"	"	11
"			AIK ROW 1			"				"	"	12
GO ++			D1-32			"				"	"	13
"			AIJ ROW 1			"				"	"	14
MKTKER			D1-33			"				"	"	15
"			ALL ROW 1			"				"	"	16
UNABLE			D1-34			"				"	"	17
"			AIH ROW 1			"				"	"	18
"						"				"	"	19
"						"				"	"	20
"						"				"	"	21
"						"				"	"	22
PWR CONTROL			D1-49			"				"	"	23
"			B-132			"				RED	"	24
GND			D1-50			"				GRY/BLK	"	25

THIS SCHEMATIC IS FURNISHED ONLY FOR TEST & MAINTENANCE PURPOSES. THE CIRCUITS ARE PROPRIETARY IN NATURE & SHOULD BE TREATED ACCORDINGLY.

NOV 4 1964

DRAFTSMAN <i>E. Messaroli</i> 1/23/64	WIRING SEQUENCE	TITLE LOT CONTROL	
CHECKED <i>N. Brouck</i> 1/23/64	CABLE LIST	DECO TAPE 550 CONTROL	
ENGINEER <i>J. L. L.</i>		ECO# IS D-2133 WAS C-201	DWG NO. A-550-0-3
			REV. LTR. D

	22	23	24	25	36	37	38	39	41	42	44	45	53	54	55	56	57	75	76	78	79	80	
TITLE	A	P	RUN PIN	ORDER	COLOR VALUE	WIRE COMP	DWG LOCATION	CONT. KEY	S	REMARKS	PAGE	LINE											
D2 JACK FEMALE																							
BIT 15	1	-	D2-16		WHT																	3	1
"	1	-	C1A ROW 1		"																	"	2
BIT 12	1	-	D2-13		"																	"	3
"	1	-	C1B ROW 1		"																	"	4
BIT 9	1	-	D2-10		"																	"	5
"	1	-	C1C ROW 1		"																	"	6
BIT 6	1	-	D2-7		"																	"	7
"	1	-	C1D ROW 1		"																	"	8
BIT 3	1	-	D2-4		"																	"	9
"	1	-	C1E ROW 1		"																	"	10
BIT 0	1	-	D2-1		"																	"	11
"	1	-	C1F ROW 1		"																	"	12
BIT 16	1	-	D2-17		"																	"	13
"	1	-	C1G ROW 1		"																	"	14
BIT 13	1	-	D2-14		"																	"	15
"	1	-	C1H ROW 1		"																	"	16
BIT 10	1	-	D2-11		"																	"	17
"	1	-	C1J ROW 1		"																	"	18
BIT 7	1	-	D2-8		"																	"	19
"	1	-	C1K ROW 1		"																	"	20
BIT 4	1	-	D2-5		"																	"	21
"	1	-	C1L ROW 1		"																	"	22
BIT 1	1	-	D2-2		"																	"	23
"	1	-	C1M ROW 1		"																	"	24
																						"	25

THIS SCHEMATIC IS FURNISHED ONLY FOR TEST & MAINTENANCE PURPOSES. THE CIRCUITS ARE PROPRIETARY IN NATURE & SHOULD BE TREATED ACCORDINGLY.

NOV 4 1964

DRAFTSMAN
C. Massadelle 1/23/64
 CHECKED
M. Blum 1/23/64
 ENGINEER

WIRING SEQUENCE
 CABLE LIST

TITLE INFO PLUG TO TAPER PINS
 LOT INFORMATION HANDLING
 DEC TAPE 550 CONTROL
 ECO# IS D-2133
 WAS C-201
 DWG NO. A-550-0-3

REV. LTR. D

1	22	23	24	25	36	37	38	39	41	42	44	45	53	54	55	56	57	75	76	78	79	80	
TITLE	A	P	RUN PIN	ORDER	COLOR VALUE	WIRE COMP	DWG LOCATION	CONT. KEY	S	REMARKS	PAGE	LINE											
BIT 17	1	-	D2-18		WHT																4	1	
"	1	-	C1N ROW 1		"																"	2	
BIT 14	1	-	D2-15		"																"	3	
"	1	-	C1P ROW 1		"																"	4	
BIT 11	1	-	D2-12		"																"	5	
"	1	-	C1R ROW 1		"																"	6	
BIT 8	1	-	D2-9		"																"	7	
"	1	-	C1S ROW 1		"																"	8	
BIT 5	1	-	D2-6		"																"	9	
"	1	-	C1T ROW 1		"																"	10	
BIT 2	1	-	D2-3		"																"	11	
"	1	-	C1U ROW 1		"																"	12	
MMIOB 15	1	+	D2-34		YEL																PIN HAS 2 WIRES	"	13
"	1	+	C1A ROW 3		"																"	14	
MMIOB 12	1	+	D2-31		"																"	15	
"	1	+	C1B ROW 3		"																2 WIRES	"	16
MMIOB 9	1	+	D2-28		"																"	17	
"	1	+	C1C ROW 3		"																"	18	
MMIOB 6	1	+	D2-25		"																"	19	
"	1	+	C1D ROW 3		"																"	20	
MMIOB 3	1	+	D2-22		"																2 WIRES	"	21
"	1	+	C1E ROW 3		"																"	22	
MMIOB 0	1	+	D2-19		"																"	23	
"	1	+	C1F ROW 3		"																"	24	
MMIOB 16	1	+	D2-35		"																2 WIRES	"	25

THIS SCHEMATIC IS FURNISHED ONLY FOR TEST & MAINTENANCE PURPOSES. THE CIRCUITS ARE PROPRIETARY IN NATURE & SHOULD BE TREATED ACCORDINGLY.

NOV 4 1964

DRAFTSMAN
E. Marsarelli 1/23/64
 CHECKED
N. Beault 1/23/64
 ENGINEER
202

WIRING SEQUENCE
 CABLE LIST

TITLE
 INFO PLUG TO TAPER PINS
 10T INFORMATION HANDLING
 DECC TAPE 550 CONTROL
 ECO#
 IS D-2133
 WAS C-201
 DWG NO.
 A-550-0-3
 REV. LTR.
 D

	22	23	24	25	36	37	38	39	41	42	44	45	53	54	55	58	57	75	76	78	79	80			
TITLE	A.	P.	RUN	PIN	ORDER	COLOR VALUE	WIRE COMP	DWG	LOCATION	CONT. KEY	S	REMARKS	PAGE	LINE											
MMIOB-16	1	+	C1G	ROW 3		YEL																5	1		
MMIOB-13	1	+	D2-32			"																	"	2	
"	1	+	C1H	ROW 3		"																	"	3	
MMIOB-10	1	+	D2-29			"																	"	4	
"	1	+	C1J	ROW 3		"																	"	5	
MMIOB-7	1	+	D2-26			"																	"	6	
"	1	+	C1K	ROW 3		"																	"	7	
MMIOB-4	1	+	D2-23			"																		"	8
"	1	+	C1L	ROW 3		"																		"	9
MMIOB-1	1	+	D2-20			"																		"	10
"	1	+	C1M	ROW 3		"																		"	11
MMIOB-17	1	+	D2-36			"																		"	12
"	1	+	C1N	ROW 3		"																		"	13
MMIOB-14	1	+	D2-33			"																		"	14
"	1	+	C1P	ROW 3		"																		"	15
MMIOB-11	1	+	D2-30			"																		"	16
"	1	+	C1R	ROW 3		"																		"	17
MMIOB-8	1	+	D2-27			"																		"	18
"	1	+	C1S	ROW 3		"																		"	19
MMIOB-5	1	+	D2-24			"																		"	20
"	1	+	C1T	ROW 3		"																		"	21
MMIOB-2	1	+	D2-21			"																		"	22
"	1	+	C1U	ROW 3		"																		"	23
(4) MMB1 ¹	1	+	D2-31			"																		"	24
"	1	+	A1H	ROW 3		"																		"	25

THIS SCHEMATIC IS FURNISHED ONLY FOR TEST & MAINTENANCE PURPOSES. THE CIRCUITS ARE PROPRIETARY IN NATURE & SHOULD BE TREATED ACCORDINGLY.

NOV 4 1964

DRAFTSMAN <i>E. Massaroli 1/23/64</i>	WIRING SEQUENCE	TITLE INFO PLUG TO TAPER PINS 10T INFORMATION HANDLING
CHECKED <i>N. B. Bault 1/23/64</i>	CABLE LIST	DEC C TAPE 550 CONTROL
ENGINEER <i>202</i>	ECO# IS <u>D-2133</u> WAS <u>C-201</u>	DWG NO. A-550-0-3
		REV. LTR. D

22	23	24	25	36	37	38	39	41	42	44	45	53	54	55	56	57	75	76	78	79	80
TITLE	A	P	RUN PIN	ORDER	COLOR VALUE	WIRE COMP	DWG LOCATION	CONT. KEY	S	REMARKS	PAGE	LINE									
(4) MMB12 ⁰	1	+	D2-38		YEL												6				1
"	1	+	AlJ ROW 3		"												"				2
GO			D2-31		"												"				3
"			AlU ROW 3		"												"				4
REV			D-32		"												"				5
"			AlT ROW 3		"												"				6
MODE 1			D2-34		"												"				7
"			AlV ROW 1		"												"				8
MODE 2			D2-35		"												"				9
"			AlU ROW 1		"												"				10
MODE 3			D2-36		"												"				11
"			AlV ROW 3		"												"				12
UNIT SEL 4	1	+	D2-21		"												"				13
"			AlD ROW 3		"												"				14
UNIT SEL 3			D2-22		"												"				15
"			AlC ROW 3		"												"				16
UNIT SEL 2			D2-23		"												"				17
"			AlB ROW 3		"												"				18
UNIT SEL 1	1	+	D2-24		"												"				19
"			AlA ROW 3		"												"				20
GND			D2-50		BLK												"				21
"			GND		"												"				22
WRTRM RETURN			B3B		RED												"				23
"			B4B		"												"				24
"			AlT ROW 3		"												"				25

THIS SCHEMATIC IS FURNISHED ONLY FOR TEST & MAINTENANCE PURPOSES. THE CIRCUITS ARE PROPRIETARY IN NATURE & SHOULD BE TREATED ACCORDINGLY.
 NOV 4 1964

DRAFTSMAN <i>E. Muscarelli 1/23/64</i>		WIRING SEQUENCE CABLE LIST	TITLE INFO PLUG TO TAPER PINS IOT INFORMATION HANDLING DEC TAPE 550 CONTROL SELECTION PLUG FROM T.P. BLK.	
CHECKED <i>M. Beault 1/23/64</i>			ECO# IS <u>D-2133</u> WAS <u>C-201</u>	DWG NO. <u>A-550-0-3</u>
ENGINEER <i>J.P.</i>				

	22	23	24	25	36	37	38	39	41	42	44	45	53	54	55	56	57	75	76	78	79	8		
TITLE	A	P	RUN	PIN	ORDER	COLOR VALUE	WIRE COMP	DWG	LOCATION	CONT. KEY	S	REMARKS	PAGE	LINE										
(-15)			B3C			RED																	7	1
"			B4C			"																	"	2
"			A5P	ROW 3		"																	"	3
GND			B3D			BLK																	"	4
"			B4D			"																	"	5
"			A5R	ROW 3		"																	"	6
GO			B3E			WHT																	"	7
"			B4E			"																	"	8
"			A5S	ROW 3		"																	"	9
FWD			B3F			"																	"	10
"			B4F			"																	"	11
"			A5M	ROW 3		"																	"	12
REV			B3H			"																	"	13
"			B4H			"																	"	14
"			A5N	ROW 3		"																	"	15
WR/LOCK			B3J			"																	"	16
"			B4J			"																	"	17
"			A5U	ROW 3		"																	"	18
STOP			B3K			"																	"	19
"			B4K			"																	"	20
"			A5A	ROW 3		"																	"	21
WRIM LITE			B3L			"																	"	22
"			B4L			"																	"	23
"			A5V	ROW 3		"																	"	24
UNIT 9			B3N			"																	"	25

THIS SCHEMATIC IS FURNISHED ONLY FOR TEST
 & MAINTENANCE PURPOSES. THE CIRCUITS ARE
 PROPRIETARY. SIGNATURE SHOULD BE TREATED
 ACCORDINGLY.

NOV 4 1964

DRAFTSMAN
E. Maccarone 1/23/64
 CHECKED
M. R. Beaulieu 1/23/64
 ENGINEER
J. E. J.

WIRING
 SEQUENCE
 CABLE
 LIST

TITLE
 SELECTION PLUG FROM T. P. BLK.
 DEC TAPE 550 CONTROL

ECO#
 IS D-2133
 WAS C-201

DWG NO.
 A-550-0-3

REV. LTR.
 D

TITLE		A	P	RUN PIN	ORDER	COLOR VALUE	WIRE COMP	DWG LOCATION	CONT. KEY	S	REMARKS	PAGE	LINE
UNIT 9				B4N		WHT						8	1
"				A5L ROW 3		"						"	2
UNIT 8				B3P		"						"	3
"				B4P		"						"	4
"				A5K ROW 3		"						"	5
UNIT 7				B3R		"						"	6
"				B4R		"						"	7
"				A5J ROW 3		"						"	8
UNIT 6				B3S		"						"	9
"				B4S		"						"	10
"				A5H ROW 3		"						"	11
UNIT 5				B3T		"						"	12
"				B4T		"						"	13
"				A5G ROW 3		"						"	14
UNIT 4				B3U		"						"	15
"				B4U		"						"	16
"				A5F ROW 3		"						"	17
UNIT 3				B3V		"						"	18
"				B4V		"						"	19
"				A5E ROW 3		"						"	20
UNIT 2				B3W		"						"	21
"				B4W		"						"	22
"				A5D ROW 3		"						"	23
UNIT 1				B3X		"						"	24
"				B4X		"						"	25

THIS SCHEMATIC IS FURNISHED ONLY FOR TEST & MAINTENANCE PURPOSES. THE CIRCUITS ARE PROPRIETARY IN NATURE & SHOULD BE TREATED ACCORDINGLY.
 NOV 4 1964

DRAFTSMAN <i>E. Massarelli 1/23/64</i>		WIRING SEQUENCE CABLE LIST	TITLE SELECTION PLUG FROM T. P. BLK. DEC TAPE 550 CONTROL	
CHECKED <i>H. Beault 1/23/64</i> ENGINEER			ECO# IS <u>D-2133</u> WAS <u>C-201</u>	DWG NO. A-550-0-3

22	23	24	25	36	37	38	39	41	42	44	45	53	54	55	56	57	75	76	78	79	80		
TITLE	A	P	RUN PIN	ORDER	COLOR VALUE	WIRE COMP	DWG LOCATION	CONT. KEY	S	REMARKS	PAGE	LINE											
UNIT 1			A5C ROW 3		WHT																9	1	
HALT			A5B ROW 3		"																		2
			B3M		"																		3
			B4M		"																		4
																							5
																							6
																							7
																							8
																							9
																							10
																							11
																							12
																							13
																							14
																							15
																							16
																							17
																							18
																							19
																							20
																							21
																							22
																							23
																							24
																							25

THIS SCHEMATIC IS FURNISHED ONLY FOR TEST & MAINTENANCE PURPOSES. THE CIRCUITS ARE PROPRIETARY IN NATURE & SHOULD BE KEPT ACCORDINGLY.
 NOV 4 1964

DRAFTSMAN
E. Muscarelli 1/23/64
 CHECKED
N. Reault 1/23/64
 ENGINEER

WIRING SEQUENCE
 CABLE LIST

TITLE SELECTION PLUG FROM T. P. BLK.
 DEC TAPE 550 CONTROL

ECO#
 IS D-2133
 WAS C-201

DWG NO.
 A-550-0-3

REV. LTR.
 D

TITLE		A	P	RUN PIN	ORDER	COLOR VALUE	WIRE COMP	DWG LOCATION	CONT. KEY	S	REMARKS	PAGE	LINE
+10V				C21B		BLU			TR		NO CONN TO C20B	1	1
"				C22B		"						"	2
"				C23B		"						"	3
"				C20B		"						"	4
-15V				C21C		RED					NO CONN TO C20C	"	5
"				C22C		"						"	6
"				C23C		"						"	7
"				C20C		"						"	8
POWER CONTROL -15V				C11		"						"	9
"				C118		"					STANDOFF	"	10
"				C18C		"						"	11
"				C19C		"						"	12
"				C20C		"						"	13
"				C24C		"						"	14
"				C25C		"						"	15
+10V A2B				A2B		"						"	16
				A82E		"						"	17
-15V A3C				A3C		"						"	18
				A82H		"						"	19
												"	20
												"	21
												"	22
												"	23
												"	24
												"	25

THIS SCHEMATIC IS FURNISHED ONLY FOR TEST & MAINTENANCE PURPOSES. THE CIRCUITS ARE PROPRIETARY IN NATURE & SHOULD BE TREATED ACCORDINGLY.

DRAFTSMAN <i>E. Magarelli 1/23/64</i>		WIRING SEQUENCE		TITLE DECO TAPE 550 CONTROL					
CHECKED <i>M. R. ... 1/23/64</i>		POWER WIRING		ECO# IS <u>D-2133</u> WAS <u>C-201</u>		DWG NO. A-550-0-4		REV. LTR. D	
ENGINEER <i>J. C. ... 1/24/64</i>									

MODULE NO.

NO. REQUIRED

4606	9
4671 "D" MODEL OR LATER	1
4218	1
4102	4
4151 "H" MODEL OR LATER	1
4303	3
4680	2
4105	1
4113	1
1011	1
4127	6
4214	3
4129	1
1 7-	1
4604	1
4115	2
4116	1
4114	1
4117	2
1113	1
4221	1
4261	1
4260	1
4228	6
4301	2
4410	2
4202	1
4401	1
4523	5
1802	1
1105	1
6102	2
1301	1

DRAWN
E. McHugh 12/13/63

CHECKED
M. Beault 1/23/64

ENG
J. Beault 1/24/64

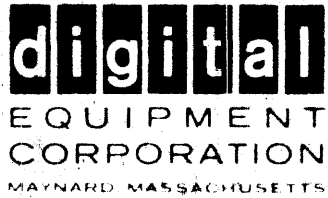

MOD

TITLE
MODULE PROCUREMENT LIST

FOR: DEC TAPE CONTROL 550

THIS SCHEMATIC IS FURNISHED ONLY FOR TEST & MAINTAINANCE PURPOSES. THE CIRCUITS ARE PROPRIETARY IN NATURE & SHOULD BE TREATED ACCORDINGLY.

NOV 4 1964

APPV
10/21/64
10/22/64
10/23/64
10/24/64
10/25/64
10/26/64
10/27/64
10/28/64
10/29/64
10/30/64
10/31/64
11/1/64
11/2/64
11/3/64
11/4/64
11/5/64
11/6/64
11/7/64
11/8/64
11/9/64
11/10/64
11/11/64
11/12/64
11/13/64
11/14/64
11/15/64
11/16/64
11/17/64
11/18/64
11/19/64
11/20/64
11/21/64
11/22/64
11/23/64
11/24/64
11/25/64
11/26/64
11/27/64
11/28/64
11/29/64
11/30/64
12/1/64
12/2/64
12/3/64
12/4/64
12/5/64
12/6/64
12/7/64
12/8/64
12/9/64
12/10/64
12/11/64
12/12/64
12/13/64
12/14/64
12/15/64
12/16/64
12/17/64
12/18/64
12/19/64
12/20/64
12/21/64
12/22/64
12/23/64
12/24/64
12/25/64
12/26/64
12/27/64
12/28/64
12/29/64
12/30/64
12/31/64

DWG NO
A-550-0-5

SHEET 1 OF 1

REV. LTR.
E

CODE
MPL

TITLE	A	P	RUN PIN	ORDER	COLOR VALUE	WIRE COMP	DWG LOCATION	CONT. KEY	S	REMARKS	PAGE
8 TERMINATOR			A4S		47 Ω	RES					1
"			GND			"					"
9 TERMINATOR			C7Y		47 Ω	"					"
"			GND			"					"
10 TERMINATOR			A19R		22 Ω	"					"
"			GND			"					"
11 TERMINATOR			B9E		47 Ω	"					"
"			GND			"					"
12 TERMINATOR			B11S		22 Ω	"					"
"			GND			"					"
13 TERMINATOR			B11Y		15 Ω	"					"
"			GND			"					"
14 TERMINATOR			B6S		47 Ω	"					"
"			GND			"					"
15 TERMINATOR			B9J		22 Ω	"					"
"			GND			"					"
16 TERMINATOR			B9M		22 Ω	"					"
"			GND			"					"
17 TERMINATOR			A24R		47 Ω	"					"
"			GND			"					"
18 TERMINATOR			B9X		47 Ω	"					"
"			GND			"					"
19 TERMINATOR			B9U		47 Ω	"					"
"			GND			"					"

THIS SCHEMATIC IS FURNISHED ONLY FOR TEST & MAINTENANCE PURPOSES. THE CIRCUITS ARE PROPRIETARY IN NATURE & SHOULD BE TREATED ACCORDINGLY.

NOV 4 1964

DRAFTSMAN <i>E. Maresella</i> 1/23/64		WIRING SEQUENCE		TITLE DEC TAPE 550 CONTROL					
CHECKED <i>N. R. Smith</i> 1/23/64		TERMINATOR LIST		ECO# IS D-2133 WAS C-207		DWG NO. A-550-0-6		REV. LTR. D	
ENGINEER <i>J. E. Stodola</i> 1/24/64									

20120A

22	23	24	25	36	37	38	39	41	42	44	45	53	54	55	56	57	75	76	78	79	80	
TITLE		A	P	RUN PIN	ORDER	COLOR VALUE	WIRE COMP	DWG LOCATION	CONT. KEY	S	REMARKS	PAGE	LINE									
1	TERM			A2M		47 Ω															2	1
	"			GND																	"	2
2	TERM			A2S		47 Ω	"														"	3
	"			GND			"														"	4
3	TERM			A3K		39 Ω	"	1NB1													"	5
	"			GND			"														"	6
4	TERM			A3P		47 Ω	"	1NB1													"	7
	"			GND			"														"	8
5	TERM			A3U		47 Ω	"														"	9
	"			GND			"														"	10
6	TERM			A4E		47 Ω	"														"	11
	"			GND			"														"	12
7	TERM			A4M		47 Ω	"														"	13
	"			GND			"														"	14
8	TERM.			A18J		15 Ω																15
	"			GND																		16
9	TERM.			A7P		15 Ω																17
	"			GND																		18
10	TERM.			A3S		39 Ω																19
	"			GND																		20
11	TERM.			A4K		47 Ω																21
	"			GND																		22
12	TERM.			B11Y		15 Ω		TMB5														23
	"			GND																		24
				B3C																		25

THIS SCHEMATIC IS FURNISHED ONLY FOR TEST
 & MAINTENANCE PURPOSES. THE CIRCUITS ARE
 PROPRIETARY IN NATURE & SHOULD BE TREATED
 ACCORDINGLY.

NOV 4 1964

DRAFTSMAN <i>E. Massarelli 11/23/64</i>		WIRING SEQUENCE	TITLE DEC. TAPE 550 CONTROL		
CHECKED <i>H. Schmitt 11/23/64</i>		TERMINATOR LIST	ECO# IS D-2133 WAS C-201		DWG NO. A-550-0-6
ENGINEER			REV. LTR. D		

22	23	24	25	36	37	38	39	41	42	44	45	53	54	55	56	57	75	76	78	79	80
TITLE			A	P	RUN PIN	ORDER	COLOR VALUE	WIRE COMP	DWG LOCATION			CONT. KEY	S	REMARKS	PAGE	LINE					
CP SR					C3V		22 Ω		1NB2								3	1			
					GND													2			
SHIFT SRL					C2V		22 Ω		1NB1										3		
					GND													4			
SHIFT SR RT					C7Z		22 Ω		1NB7										5		
					GND													6			
A6R					A6R		10 Ω											7			
					A82R													8			
A6S					A6S		10 Ω											9			
					A82S													10			
A6T					A6T		10 Ω											11			
					A82T													12			
A6U					A6U		10 Ω											13			
					A82U													14			
A6V					A6V		10 Ω											15			
					A82V													16			
A6W					A6W		10 Ω											17			
					A82W													18			
A6X					A6X		10 Ω											19			
					A82X													20			
A6Y					A6Y		10 Ω											21			
					A82Y													22			
A6Z					A6Z		10 Ω											23			
					A82Z													24			
																		25			

THIS SCHEMATIC IS FURNISHED ONLY FOR TEST
 & MAINTENANCE PURPOSES. THE CIRCUITS ARE
 PROPRIETARY IN NATURE & SHOULD BE TREATED
 ACCORDINGLY.

NOV 4 1964

DRAFTSMAN Elaine Massarelli 2/19/64		WIRING SEQUENCE		TITLE DEC TAPE 550 CONTROL					
CHECKED <i>M. K. ...</i> 2/19/64		TERMINATOR LIST		ECO# IS D-2133 WAS C-201		DWG NO. A-550-0-6		REV. LTR. D	
ENGINEER									

SPECIAL WIRING INSTRUCTIONS

1. Run regular -15V to C17C then jump to C23A and stop.
2. There is NO power wiring to pins B3A, B3B, B4A, B4B, and C21A, B, C, C22A, B, C, C23A, B, C. There is -15V wiring to B3C & B4C.
3. Run the +10AV to C20A then jump to C24A and C25A.
4. Run the +10BV to C20B then jump to C24B and C25B.
5. Do not Gnd. B3D or B4D..These have a special Gnd path.

DRAWN E. McHugh 12/13/63	 digital EQUIPMENT CORPORATION MAYNARD, MASSACHUSETTS	MOD TITLE SPECIAL WIRING INSTRUCTIONS FOR: DEC TAPE CONTROL 550
CHECKED <i>M. Rheaugh 1/23/64</i> ENG <i>J.P. Hood 1/24/64</i>	THIS SCHEMATIC IS FURNISHED ONLY FOR TESTING & MAINTAINANCE PURPOSES. THE CIRCUIT PARTS ARE PROPRIETARY IN NATURE & SHOULD BE TREATED ACCORDINGLY. NOV 4 1964 2133 257 10A A-181	DWG NO A-550-0-7 REV. LTR. C SHEET 1 OF 1 CODE S

C49 AND C54 ARE 22 PIN SOCKETS MTD. OVER C19 AND C24 ON 3/8" STANDOFFS IN A REVERSED POSITION SO THAT THE PINS FACE THE LOGIC

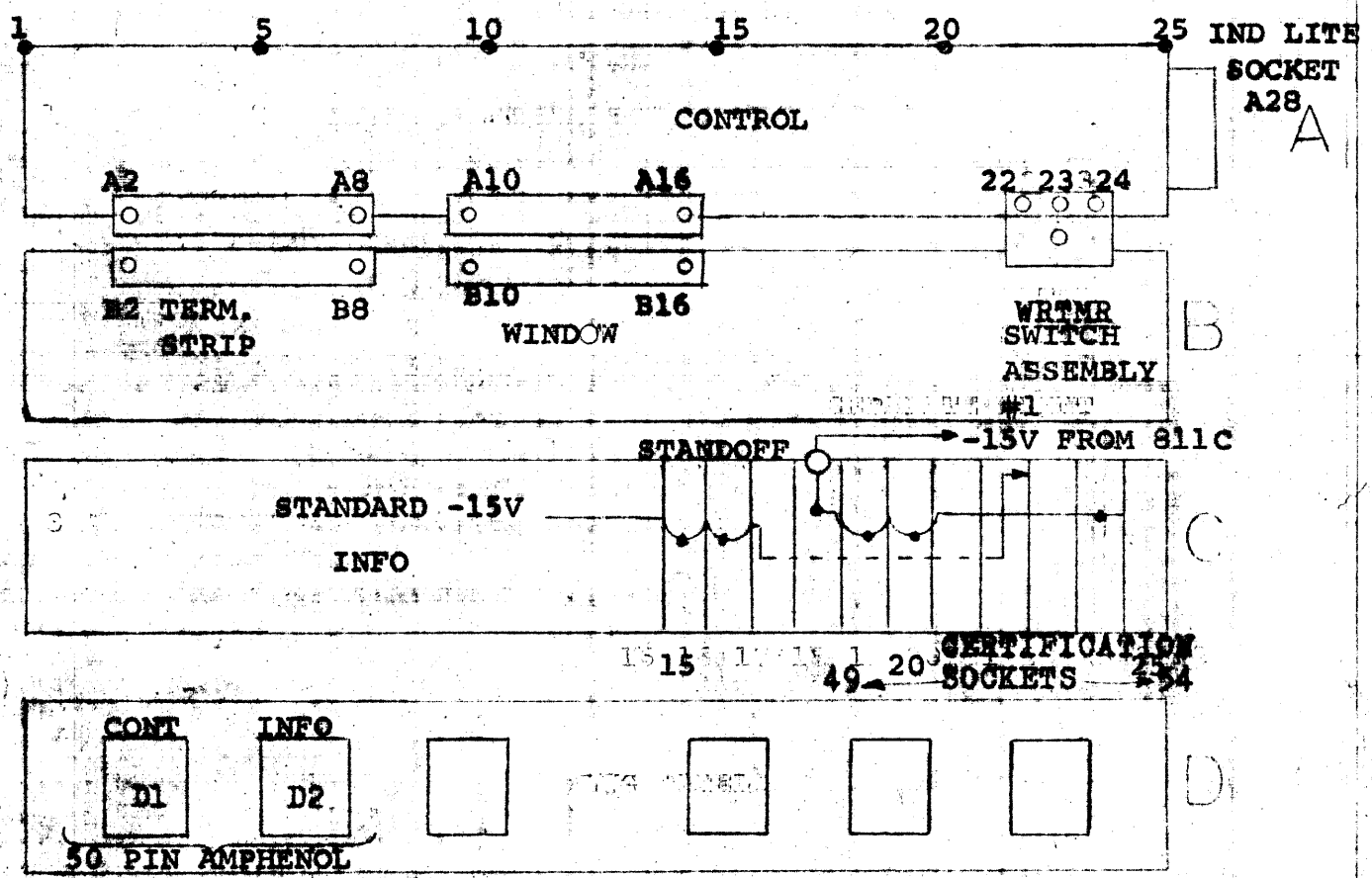

WRTR SWITCH WIRING

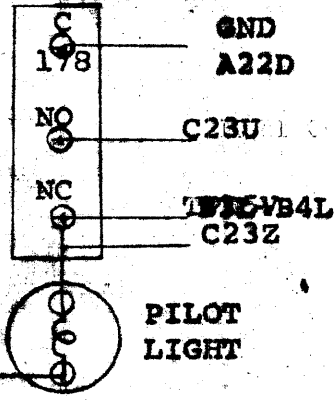

C49 AND C54 ARE 22 PIN SOCKETS MTD. OVER C19 AND C24 ON 3/8" STANDOFFS IN A REVERSED POSITION SO THAT THE PINS FACE THE LOGIC

DRAWN <i>B. Lumpkin</i> 10-23-63		digital EQUIPMENT CORPORATION MAYNARD, MASSACHUSETTS	MOD	
CHECKED <i>M. A. Russell</i> 1/23/64			TITLE	
ENG <i>S. E. ...</i> 1/29/64			DEC TAPE 550 CONTROL PANEL LAYOUT	
THIS SCHEMATIC IS FURNISHED ONLY FOR TEST & MAINTENANCE PURPOSES. THE CIRCUITS ARE PROPRIETARY IN NATURE & SHOULD BE TREATED ACCORDINGLY.		APPR. <i>[Signature]</i>	DWG NO	REV. LTR.
		ECO NO.	A-550-0-8	D
NOV 4 1964		REV. LTR.	SHEET 1 OF 1	CODE MA

22	23	24	25	36	37	38	39	41	42	44	45	53	54	55	56	57	75	76	78	79	80
TITLE			A	P	RUN PIN	ORDER	COLOR VALUE	WIRE COMP	DWG LOCATION			CONT. KEY	S	REMARKS	PAGE	LINE					
A2D					A2D		BLK.							GND.	1	1					
"					A2H		"							"	"	2					
"					A2P		"							"	"	3					
"					A2X		"							"	"	4					
"														"	"	5					
A3D					A3D		"							"	"	6					
"					A3J		"							"	"	7					
"					A3R		"							"	"	8					
"					A3W		"							"	"	9					
"														"	"	10					
A4D					A4D		"							"	"	11					
"					A4J		"							"	"	12					
"					A4R		"							"	"	13					
"					A4X		"							"	"	14					
"														"	"	15					
A11D					A11D		"							"	"	16					
"					A11T		"							"	"	17					
"														"	"	18					
A12D					A12D		"							"	"	19					
"					A12T		"							"	"	20					
"														"	"	21					
A14D					A14D		"							"	"	22					
"					A14F		"							"	"	23					
"					A14J		"							"	"	24					
"					A14M		"							GND	"	25					

THIS SCHEMATIC IS FURNISHED ONLY FOR TEST & MAINTENANCE PURPOSES. THE CIRCUITS ARE PROPRIETARY IN NATURE & SHOULD BE TREATED ACCORDINGLY.

NOV 4 1964

DRAFTSMAN
E. Morrison 11/23/64
 CHECKED
M. R. Beault 11/23/64
 ENGINEER
J. C. Strohbehn 11/23/64

WIRING SEQUENCE
 GND

TITLE
 DEC TAPE 550 CONTROL

ECO#
 IS D-2133
 WAS C-201

DWG NO.
 A-550-0-9.

REV. LTR.
 D

22	23	24	25	36	37	38	39	41	42	44	45	53	54	55	56	57	75	76	78	79	80
TITLE	A	P	RUN PIN	ORDER	COLOR VALUE	WIRE COMP	DWG LOCATION	CONT. KEY	S	REMARKS	PAGE	LINE									
A14D			A14X		BLK					GND.	2	1									
"			A14T		"					"	"	2									
												3									
A23D			A23D		"					"	"	4									
"			A23R		"					"	"	5									
"			A23X		"					"	"	6									
												7									
B6D			B6D		"					"	"	8									
"			B6J		"					"	"	9									
"			B6R		"					"	"	10									
"			B6X		"					"	"	11									
												12									
B10D			B10D		"					"	"	13									
"			B10J		"					"	"	14									
"			B10R		"					"	"	15									
"			B10W		"					"	"	16									
												17									
B11D			B11D		"					"	"	18									
"			B11J		"					"	"	19									
"			B11R		"					"	"	20									
"			B11W		"					"	"	21									
												22									
B12D			B12D		"					"	"	23									
"			B12J		"					"	"	24									
"			B12S		"					"	"	25									

THIS SCHEMATIC IS FURNISHED ONLY FOR TEST & MAINTENANCE PURPOSES. THE CIRCUITS ARE PROPRIETARY IN NATURE & SHOULD BE TREATED ACCORDINGLY.

NOV-4-1964

DRAFTSMAN
E. Massarelli 1/23/69
 CHECKED
N. Rheault 1/23/69
 ENGINEER
JEA

WIRING SEQUENCE
 GND

TITLE
 GNDs
 DEC TAPE 550 CONTROL
 ECO#
 IS D-2133
 WAS C-201
 DWG NO.
 A-550-0-9
 REV. LTR.
 D

TITLE	A	P	RUN PIN	ORDER	COLOR	WIRE	DWG LOCATION	CONT. KEY	S	REMARKS	PAGE	LINE
					VALUE	COMP						
B12D			B12V		BLK.					GND.	3	1
												2
B18D			B18D		"					"	"	3
"			B18N		"					"	"	4
"			B18T		"					"	"	5
"			B18X		"					"	"	6
			B18J									7
C10D			C10D		"					"	"	8
"			C10J		"					"	"	9
"			C10R		"					"	"	10
"			C10X		"					"	"	11
												12
C11D			C11D		"					"	"	13
"			C11F		"					"	"	14
"			C11Z		"					"	"	15
												16
C12D			C12D		"					"	"	17
"			C12Z		"					"	"	18
												19
C14D			C14D		"					"	"	20
"			C14F		"					"	"	21
C15D			C15D		"					"	"	22
"			C15F		"					"	"	23
C17D			C17D		"					"	"	24
"			C17E		"					"	"	25

THIS SCHEMATIC IS FURNISHED ONLY FOR TESTS & MAINTENANCE PURPOSES. THE CIRCUITS ARE PROPRIETARY IN NATURE & SHOULD BE TREATED ACCORDINGLY.

NOV 7 1964

DRAFTSMAN
E. Masselli 1/23/64
 CHECKED
M. Pleault 1/23/64
 ENGINEER
J. L. A.

WIRING SEQUENCE
 GND

TITLE
 DEC. TAPE 550 CONTROL
 GNDs

ECO#
 IS D-2133
 WAS C-201

DWG NO.
 A-550-0-9

REV. LTR.
 D

22	23	24	25	36	37	38	39	41	42	44	45	53	54	55	56	57	75	76	78	79	80	
TITLE			A	P	RUN PIN	ORDER	COLOR VALUE	WIRE COMP	DWG LOCATION			CONT. KEY	S	REMARKS	PAGE	LINE						
C21E					C21E		BLK										NOT TO C21D	4			1	
"					C21K		"											"			2	
"					C21M		"											"			3	
"					C21S		"											"			4	
"					C21W		"											"			5	
C22E					C22E		"											NOT TO C22D	"			6
"					C22K		"												"			7
"					C22M		"												"			8
"					C22S		"												"			9
"					C22W		"												"			10
A16Y					A16Y		"												"			11
"					GND		"												"			12
C23J					C23J		"											NO "D" CONNECTION	"			13
A82F					A82F		"												"			14
"					GND		"												"			15
"					B62R		"												"			16
B62R					B62S		"												"			17
"					B62T		"												"			18
"					B62U		"												"			19
"					B62V		"												"			20
"					B62W		"												"			21
"					B62X		"												"			22
"					B62Y		"												"			23
"					B62Z		"												"			24

THIS SCHEMATIC IS FURNISHED ONLY FOR TEST & MAINTENANCE PURPOSES. THE CIRCUITS ARE PROPRIETARY IN NATURE & SHOULD BE TREATED ACCORDINGLY.

NOV 4 1964

DRAFTSMAN
E. Massarelli 1/23/64
GND

CHECKED
M. Pheault 1/23/64
GND

ENGINEER
J.P.A.

WIRING SEQUENCE

TITLE
DECO TAPE 550 CONTROL
GNDS

ECO#
IS D-2133
WAS C-201

DWG NO.
A-550-0-9

REV. LTR.
D

1	4228	4102 -775	1501
2	4228	4680	4606 X *
3	4228	SELECT PLUG #1	4606 X *
4	4228 JUMPERS	SELECT PLUG #2	4606-R
5	4228 TO "1"	4129	4606*
6	4228 SIDE	4606 X *	4671 D MODEL OR LATER
7	4228	1011 2,2,2,2,2,2,(STD)	4218
8	1011 2,2,2,2,2,2	1011 3,4,2,2	4102-R
9	4114-13	4127-R	4218
10	4606 X *	4606 X *	4151 "H" MODEL OR LATER
11	4301	4606 X *	4303
12	4301	4604	4303
13	4117-R	4102-R	4680
14	4410	4115-R	1105
15	4410	4116-1	4102-R
16	4302	4102-R	4113-R
17	4401	4214	1011 2,2,3,3,2
18	4523	4105	4127 X *
19	4523	4117-3	4214
20	4523	4115-X	4127 X *
21	HEAD PLUG #1	6102-R	1011 2,2,2,2,2,2,(STD)
22	HEAD PLUG #2	4221-17/PRESET--100000	4127 X *
23	1802	4127 X *	4606 R
24	4523	4261	4127 X *
25	4523	4260	4214

* MEANS REMOVE ALL JUMPERS

C

B

A

DRAWN <i>B. D. Campbell</i> 10-23-63	 EQUIPMENT CORPORATION MAYNARD, MASSACHUSETTS	MOD
CHECKED <i>M. P. ... 11/23/64</i>		TITLE MODULE LOCATION-MODULE JUMPING.
ENG <i>J. D. ... 2 Jan 64</i>	FOR: DEC TAPE CONTROL 550	DWG NO A-550-0-10
THIS SCHEMATIC IS FURNISHED ONLY FOR TEST & MAINTENANCE PURPOSES. THE CIRCUITS ARE PROPRIETARY IN NATURE & SHOULD BE TREATED ACCORDINGLY.	APPV <i>J. D. ...</i> ECO NO. REV. LTR.	REV. LTR. E
	NOV 4 1964 <i>D-251</i> <i>3-201</i> <i>6-185</i> <i>4-181</i>	SHEET 1 OF 1

22	23	24	25	36	37	38	39	41	42	44	45	53	54	55	56	57	75	76	78	79	80			
TITLE	A	P	RUN PIN	ORDER	COLOR VALUE	WIRE COMP	DWG LOCATION	CONT. KEY	S	REMARKS	PAGE	LINE												
																					1	1		
																						"	2	
B15L			B15L			"																"	3	
"			B15C			"																"	4	
B23Y			B23Y			"																"	5	
"			B23C			"																"	6	
																						"	7	
																						"	8	
DIODE 1		+	A11S																				"	9
"		-	A141																				"	10
DIODE 2		-	A11K																				"	11
"		+	A11D																				"	12
DIODE 3		-	B15L																				"	13
"		+	B115																				"	14
																							"	15
																							"	16
RESISTOR 1			A141																				"	17
"			B11A																				"	18
CAPACITOR 1			A141																				"	19
"			A11K																				"	20
CAPACITOR 2			C9V																				"	21
"			GND																				"	22
CAPACITOR 3			C9Z																				"	23
"			GND																				"	24
																							"	25

THIS SCHEMATIC IS FURNISHED ONLY FOR TEST & MAINTENANCE PURPOSES. THE CIRCUITS ARE ACCORDINGLY IN NATURE & SHOULD BE TREATED ACCORDINGLY.

NOV 4 1964

DRAFTSMAN <i>Marsaglia 1/3/64</i>		WIRING SEQUENCE	TITLE DEC TAPE 550 CONTROL	
CHECKED <i>J. Rheault 1/23/64</i>		COMPONENTS LIST	ECO# IS <u>D-2133</u> WAS <u>e-201</u>	
ENGINEER <i>J. Stodolna 2/6/64</i>			DWG NO. A-550-0-11	
			REV. LTR. D	

201-204

22	23	24	25	36	37	38	39	41	42	44	45	53	54	55	56	57	75	76	78	79	80	
TITLE			A	P	RUN PIN	ORDER	COLOR VALUE	WIRE COMP	DWG LOCATION	CONT. KEY	S	REMARKS					PAGE	LINE				
A2L			A2L				BRN	RES													2	1
"			A2C					"														2
A2T			A2T					"														3
"			A2C					"														4
A4Z			A4Z					"														5
"			A4C					"														6
A18N			A18N					"														7
"			A18C					"														8
B5L			B5L					"														9
"			B5C					"														10
A82E			A82E				BRN	RES														11
			B62E																			12
A82F			A82F				"	DIODE														13
			B62F																			14
A82H			A82H				"	RES														15
			B62H																			16
A82J			A82J				"	DIODE														17
			B62J																			18
A82K			A82K				"	DIODE														19
			B62K																			20
A62K			A62K				"	RES														21
			A82E																			22
																						23
																						24
																						25

THIS SCHEMATIC IS FURNISHED ONLY FOR TEST & MAINTENANCE PURPOSES. THE CIRCUITS ARE PROPRIETARY IN NATURE & SHOULD BE TREATED ACCORDINGLY.

NOV 4 1964

DRAFTSMAN
E. Marcelli 1/23/64

CHECKED
M. Healey 1/23/64

ENGINEER

WIRING SEQUENCE

COMPONENTS LIST

TITLE
DEC TAPE 550 CONTROL

ECO#
IS D-2133
WAS C-201

DWG NO.
A-550-0-11

REV. LTR.
D

SHEET 2 OF 3

22	23	24	25	36	37	38	39	41	42	44	45	53	54	55	56	57	75	76	78	79	80
TITLE			A	P	RUN PIN	ORDER	COLOR VALUE	WIRE COMP	DWG LOCATION			CONT. KEY	S	REMARKS			PAGE	LINE			
CAP. #1					A82R		BRN							.01 MFD. 50V.			3	1			
					B62R													2			
CAP. #2					A82S									"				3			
					B62S													4			
CAP. #3					A82T									"				5			
					B62T													6			
CAP. #4					A82U									"				7			
					B62U													8			
CAP. #5					A82V									"				9			
					B62V													10			
CAP. #6					A82W									"				11			
					B62W													12			
CAP. #7					A82X									"				13			
					B62X													14			
CAP. #8					A82Y									"				15			
					B62Y													16			
CAP. #9					A82Z									"				17			
					B62Z													18			
																		19			
																		20			
																		21			
																		22			
																		23			
																		24			
																		25			

THIS SCHEMATIC IS FURNISHED ONLY FOR TEST
 & MAINTENANCE PURPOSES. THE CIRCUITS ARE
 PROPRIETARY IN NATURE & SHOULD BE TREATED
 ACCORDINGLY.

NOV 4 1964

DRAFTSMAN		WIRING SEQUENCE	TITLE		
CHECKED		COMPONENT LIST	DECOTAPE 550 CONTROL COMPONENTS		
ENGINEER			ECO# IS <u>D-2133</u> WAS <u>C-201</u>	DWG NO. A-550-0-11	REV. LTR. D

SPARE PARTS LIST

QTY	MODEL NO.	TITLE
1	4523	READER WRITER
1	4260	MARK TRACK DECODER
1	4261	MARK SYNC DECODER
1	4671	DECODER

ONE (1) REPLACEMENT SCHEMATIC AND A DESCRIPTION OF EACH OF THE ABOVE MODULES.

DRAWN P.J. Priest 1-31-64		 digital EQUIPMENT CORPORATION MAYNARD, MASSACHUSETTS	TITLE	
CHECKED <i>[Signature]</i>			SPARE PARTS LIST	
ENG <i>[Signature]</i>			FOR DEC TAPE CONTROL 550	
THIS SCHEMATIC IS FURNISHED ONLY FOR TEST & MAINTAINANCE PURPOSES. THE CIRCUITS ARE PROPRIETARY IN NATURE & SHOULD BE TREATED ACCORDINGLY.				
NOV 4 1964			APPV A-2133	ECO. NO. REV. LTR.
			DWG NO A-550-0-12	REV. LTR. A
			SHEET 1 OF 1	CODE MN

OUTLINE OF DECTAPE CHECKOUT PROCEDURE

General

Test Equipment

- Tester
- Scope
- Computer
- Test Tapes
- Writeups

ECO Procedures

Detailed Procedure

I. Basics

- Prints
- jumpers

II. Power

III. Control Pulses (IOT's)

- M MDF
- M MEF
- M MLL
- M MMSE

Power Clear

IV. Selection Control

V. Motion Control & Mode Selection

- Mode Bits & Decoder
- GO, REV flops
- Start & Reverse Delays
- Clear Window

VI. WRTM MODE

- Clock, relay
- Error Counter
- Preset & Shift pulses
- Operation

VII. WREN FLOP

- Operation
- Write Interlocking

DRAWN P.J. Priest 2/28/64		 EQUIPMENT CORPORATION MAYNARD, MASSACHUSETTS	TITLE CHECKOUT PROCEDURE	
CHECKED <i>M. J. ... 3/1/64</i>				
ENG <i>J. C. ... 3/10/64</i>		THIS SCHEMATIC IS FURNISHED ONLY FOR TEST & MAINTAINANCE PURPOSES. THE CIRCUITS ARE PROPRIETARY IN NATURE & SHOULD BE TREATED ACCORDINGLY.		
NOV 4 1964 A-2133				
ECO. NO. REV. LTR.		DWG NO A-550-0-13		REV. LTR. A
		SHEET 1 OF 34		CODE CP

VIII. Timing Pulses and their derivatives

- TPO
- TP1
- TP2

IX. Information Buffer & Shift Register

- Data Flag
- MM10B
- SR

X. Read Amplifiers/Writers

XI. Mark & Mark Error Detection

- Window outputs
- Mark Sync outputs
- Error Detection

XII. Error Status Conditions

DECTAPE 555/550 CHECKOUT PROCEDURE

Test Equipment:

Scope - Normal CA or other 2 trace presentation scope is enough but a millivolt preamplifier (Type D) and dual shielded direct probe is necessary at Section X. Two scopes - or one dual beam scope - equipped with two millivolt preamps are needed for the skew measurement.

Tester - This consists of -

1. A delay line pulse oscillator which can provide recurrent pulses on the various lines to the tape control. (See sketch with this procedure.)
2. A set of indicators connected to the tape IO buffer.
3. A set of indicators connected to the tape status bit.

DRAWN P.J. Priest 2/28/64		 digital EQUIPMENT CORPORATION MAYNARD, MASSACHUSETTS	TITLE CHECKOUT PROCEDURE	
CHECKED <i>M. J. Priest</i> 3/9/64				
ENG <i>J. P. Priest</i>				
THIS SCHEMATIC IS FURNISHED ONLY FOR TEST & MAINTAINANCE PURPOSES. THE CIRCUITS ARE PROPRIETARY IN NATURE & SHOULD BE TREATED ACCORDINGLY.				
NOV 4 1964				
		APP'V		
		ECO. NO.	DWG NO	
		REV. LTR.	A-550-0-13	
			SHEET 2 OF 34	
			REV. LTR. A	
			CODE CP	

4. A pulse generator which is triggered by various "flag up" transitions and which will return a "load buffer" or "unload buffer" (MMWR or MMRD) pulse after a delay.
5. A set of switches to provide mode commands and information via the lines which normally hook to the computer's I/O or AC.
6. The REVERSE and GO command lines can be connected to a complementary flip flop. Many of the foregoing functions can, of course, be provided by a computer. The Microtog programs for the -1 and -4 machines provide the necessary subroutines.
7. A REVERSE TAPE transport is also necessary. It may be provided in the equipment being checked out.

Computer. For actual margins and final bit-by-bit error detection, a computer is necessary. The Microtog subroutines provide the necessary programs. The procedure for checkout with a computer follows this one.

Test Tapes. One tape written with a standard pattern in the mark track and a so-called virgin tape pattern is necessary.

Prints. Before starting checkout procedure it is MANDATORY that one set of block schematics (C1, C2, TM, W, 1, BD, Timing Chart) and the set of production prints that were actually used to manufacture the items be available. (Module location list, wiring list, cable lists, etc.). These must be bound together in some form or another. On these prints all discrepancies will be noted and finally sent along with the machine when checkout is complete.

The basic procedure is to check the operation of the system and in the process generate -

1. A written list of discrepancies

DRAWN P.J. Priest 2/28/64		 digital EQUIPMENT CORPORATION MAYNARD, MASSACHUSETTS	TITLE CHECKOUT PROCEDURE		
CHECKED <i>M. J. Priest</i> 3/9/64					
ENG. <i>J. C. Stodolne</i>					
THIS SCHEMATIC IS FURNISHED ONLY FOR TEST & MAINTAINANCE PURPOSES. THE CIRCUITS ARE PROPRIETARY IN NATURE & SHOULD BE TREATED ACCORDINGLY.		APP'V			
		NOV 4 1964	ECO. NO.	DWG NO	REV. LTR.
			REV. LTR.	A-550-0-13	A
				SHEET 3 OF 34	CODE CP

2. (A marked up) set of block schematics which exactly agree with the equipment.

3. Engineering change orders as appropriate to correct those deficiencies which were present because of incorrect instructions to Production and Checkout. They should also be generated to improve the tester design or overall system reliability.

4. The checkout procedure itself should be updated as design changes and bugs are discovered. It will be used also to revise the Field Test procedure.

One copy of the discrepancies list should be kept permanently by Checkout to assist in checking out further systems. A copy may go along with the prints to the PE or designer. Engineering change orders should be generated as indicated a little further along in this report and will be used to update the present block schematics and plant the seeds for future corrections of the system. These ECO's should be forwarded to the Project Engineer for further processing. Note that these must be forwarded on the same day that the discrepancy was executed if the prints are to be reasonably up to date. At the end of checkout, Quality Control will obtain several brand new sets of prints (which must be on microfilm and listed on the key sheet) and check them against the marked up set to ascertain their accuracy.

ECO Procedure Checkout originates ECOs for the following reasons in order of urgency.

1. To revise the specific prints applying to the machine
2. To revise the machines which are in process of construction
3. To revise the prints used in construction of future machines (wiring lists, etc.)
4. To revise the prints used in checkout and field maintenance of future machines (block schematics).

DRAWN P.J. Priest 2/28/64		 digital EQUIPMENT CORPORATION MAYNARD, MASSACHUSETTS	TITLE CHECKOUT PROCEDURE	
CHECKED <i>[Signature]</i> 3/7/64				
ENG <i>[Signature]</i>			DWG NO A-550-0-13 SHEET 4 OF 34	
THIS SCHEMATIC IS FURNISHED ONLY FOR TEST & MAINTAINANCE PURPOSES. THE CIRCUITS ARE PROPRIETARY IN NATURE & SHOULD BE TREATED ACCORDINGLY.		APPV ECO. NO. REV. LTR.		
		NOV 4 1964		

5. To update the checkout and test procedures themselves.

The Checkout Department need only originate ECOs (daily). It is up to the Project Engineer or the ECO procedure in Drafting, to follow up and send them wherever they must go. The following items should be mentioned in the ECO form as it is originated. Only the first item is absolutely mandatory - the others are helpful.

EXAMPLE

- | | |
|--------------------------------------------------------------------------------------------------------------------------------------------------------------------------------------------------------|------------------------------------------------------------|
| 1. A word description of the change | Buffers inserted in MMIOB buss |
| 2. The wiring that was changed | Move B 23A from B21A |
| 3. What was actually done to the machine being checked | Above change done to Serial #69-550 |
| 4. A reason for the change | Too much loading on buss |
| 5. The prints affected | ClB Revision B for Kie and its wiring list |
| 6. The machine's effect | Affects machines after Serial 73, not machines in progress |
| 7. If the change affects machines in progress, rather than future machines, then a detailed description (for the Production girls to execute) of the mod would be supplied. This is similar to Item 2. | |

The first item only is mandatory but No. 3 is easy to supply since all prints affected are with the checkout people. No. 7 can, in many cases, be supplied by the checkout people since, in general, they have to modify the current machine already. Machines modified in process will ordinarily not look the same in future production models as in the work in process machines because other mods will go along with those in the future machines and basic wire runs will then be different.

DRAWN P.J. Priest 2/28/64		 digital EQUIPMENT CORPORATION MAYNARD, MASSACHUSETTS	TITLE CHECKOUT PROCEDURE		
CHECKED <i>N. Heault 3/9/64</i>					
ENG <i>JL</i>					
THIS SCHEMATIC IS FURNISHED ONLY FOR TEST & MAINTAINANCE PURPOSES. THE CIRCUITS ARE PROPRIETARY IN NATURE & SHOULD BE TREATED ACCORDINGLY.		APPV	DWG NO A-550-0-13		
NOV 4 1964		ECO. NO. REV. LTR.			REV. LTR. A
			SHEET	5 OF 34	CODE CP

The usual system will be a rack containing a 550 control, some 555 Transports (previously checked out individually before assembly in the rack), a 734 marginal check supply and its control panel and a 728 power supply with a modified 811 power control. In the future, the 555 controls all by themselves should be checked out and sitting on the shelf.

DRAWN
P.J. Priest 2/28/64
 CHECKED
W. Rhoads 3/2/64
 ENG
ZOA

digital
 EQUIPMENT
 CORPORATION
 MAYNARD, MASSACHUSETTS

TITLE
CHECKOUT PROCEDURE

THIS SCHEMATIC IS FURNISHED ONLY FOR TEST & MAINTAINANCE PURPOSES. THE CIRCUITS ARE PROPRIETARY IN NATURE & SHOULD BE TREATED ACCORDINGLY.

Apprv

NOV 4 1964

ECO. NO.
 REV. LTR.

DWG NO
A-550-0-13

REV. LTR.
A

SHEET 6 OF 34

CODE
CP

DETAILED CHECK PROCEDURES

(One copy to be filled out and kept with each control)

1. BASIC STEPS

OBSERVATIONS

A. Check and record on Key Sheet and BLI all serial number, of 550, 555, cabinet assemblies and so on.

CK _____

B. Obtain all prints:

1. Prints that were used to produce the items.

2. Checkout prints:

C1, C2, 1, TM, W, BD, 811 Power Control Timing Diag. UML.

Consult master print list for correct revisions and see that they exist.

CK _____

C. Check that master print list and key sheet adequately cover equipment checked

CK _____

D. Check all modules with jumper options against the UML and see that all modules and plugs are installed

CK _____

E. Plug in tester and AC power and 555 drive (two wires + AC) if necessary

CK _____

DRAWN
P.J. Priest 2/28/64

CHECKED
[Signature] 3/2/64

ENG
[Signature]

digital

EQUIPMENT CORPORATION
MAYNARD, MASSACHUSETTS

TITLE

CHECKOUT PROCEDURE

THIS SCHEMATIC IS FURNISHED ONLY FOR TEST & MAINTAINANCE PURPOSES. THE CIRCUITS ARE PROPRIETARY IN NATURE & SHOULD BE TREATED ACCORDINGLY.

APPV

NOV 4 1964

ECO. NO.
REV. LTR.

DWG NO
A-550-0-13

REV. LTR.
A

SHEET 7 OF 34

CODE
CP

F. Remove one end of diode between B1SL and A19Z (C2A5) to disable error loop CK _____

G. Mark on side of chassis the numbers of all block schematics which apply. CK _____

II Power

A. Apply power-watch for smoke CK _____

B. Local remote switch on 811
UP (local) = Power on

DN (Remote) = Power off if -15 switch on tester is off. Check operation (Leave in remote) CK _____

C. Check -15 dump to writers:

SYNC On -15 switch sync

jack on tester. When it is turned off -15 at C18C should disappear well before the rest of the -15 from the 728 power supply. C18C _____ MS

D. Measure AC current to 728 and to drives and total current. (Clamp on ammeter) -15 _____ MS
Total _____ Amps

728 _____ Amps

Drives _____ Amps

E. Check marginal check supply output for correctness using a simpson on one back panel and varying the voltage, Compare meter readings. _____ OK

DRAWN
P.J. Priest 2/28/64
CHECKED
H. H. ...
ENG
JCA



TITLE
CHECKOUT PROCEDURE

THIS SCHEMATIC IS FURNISHED ONLY FOR TEST & MAINTAINANCE PURPOSES. THE CIRCUITS ARE PROPRIETARY IN NATURE & SHOULD BE TREATED ACCORDINGLY.

APP'Y

NOV 4 1964

ECO. NO.
REV. LTR.

DWG NO
A-550-0-13

REV. LTR.
A

SHEET **8** OF **34**

CODE
CP

III. CONTROL PULSES

Start tester's delay loop (Fast) to generate continuous pulses on buss to control switches.

Sync on pulse output from delays to buss. The scope _____

will remain sync like this all the way to Section IV page 12. _____

Find pulses on buss for time measurement (expand the time scale to see the pulse well). All buss switches off. _____

A. MMDF and MMEF

1. Select MMDF + MMEF on rotary switch. Check pulse at A3K, S. (C1C4). Change terminator at _____ (and record fact) if necessary to reduce pulse to 2.7V max. Height _____ V
Term _____ O

2. Make MBB12 = 0 with toggle on tester. Check for -3V at A3T, A4T A4T _____ V
Measure MMDF pulse at tester jack. Make MBB12=1; Pulse Gone? Height _____ V
Quality _____

3. With MBB12=1 (check +3 at A3L, A4L) A4L _____ V
Check MMEF pulse at tester jack Height _____ V
MBB12=0; Pulse Gone? Quality _____

DRAWN
P.J. Priest 2/28/64
CHECKED
H. Priest 3/7/64
ENG
PA



TITLE
CHECKOUT PROCEDURE

THIS SCHEMATIC IS FURNISHED ONLY FOR TEST & MAINTAINANCE PURPOSES. THE CIRCUITS ARE PROPRIETARY IN NATURE & SHOULD BE TREATED ACCORDINGLY.

NOV 4 1964

DWG NO
A-550-0-13
REV. LTR.
A
SHEET 9 OF 34
CODE CP

APPV
ECO NO
REV LTR

III. A.

4. Turn off MMDF + EF for good

Negat _____

B. MMLC + MMSE

1. Turn on "MMLC + MMSE" pulses. Check eight (max. 2.7 (same scope syncing on pulse outputs of Delay to Buss)) and terminate at A4S (C1C3) if necessary.

H _____ V
Q _____
Term _____

2. With MBB12=0 check MMLC at A18E (C1C5) and change term if >2.7V (Record fact). Reduce incoming pulse with "substandard" PB on tester and make sure MMLC still exits. Look also for MMLC at A2K (C1B4) Make MBB12=1 and check for no MMLC.

A18E _____ V
Q _____
TERM _____
A2K _____
A2K _____

3. Repeat (2). Looking for MMSE at A7P (C1C2) and A2E (C1B3). With MBB12=1 check MMSE at A7P (C1C2) and change term if pulse is >2.7 volts (record fact). Reduce A7P incoming pulse with "substandard" PB on tester A2E and make sure MMSE still exits. Look also for A2E MMSE A2E. (C1B3). Make MBB12=0 and check for no MMSE.

A7P _____ V
Q _____
Term _____
A2E _____
A2E _____

Look also for no SE at A2K.

A2K _____

DRAWN
P.J. Priest 2/28/64
CHECKED
M. McLaughlin 3/9/64
ENG
LCN

digital
EQUIPMENT
CORPORATION
MAYNARD, MASSACHUSETTS

TITLE

CHECKOUT PROCEDURE

THIS SCHEMATIC IS FURNISHED ONLY FOR TEST & MAINTAINANCE PURPOSES. THE CIRCUITS ARE PROPRIETARY IN NATURE & SHOULD BE TREATED ACCORDINGLY.

APP. V

NOV 4 1964

ECO. NO.
REV. LTR.

DWG NO

A-550-0-13

REV. LTR.

A

SHEET

10 OF 34

CODE
CP

4. Turn off "MMLC + MMSE" pulses. Supply "MMSE" and check its existence at A4E (C1C3). Change terminator if necessary to lower pulse to 2.5-2.7V.

A4E	_____
Term	_____

5. Check output of PA for pulses. (A4H). Turn off pulse supply; pulses should stop.

A4H	_____
A4H	_____

6. Supply "MMLC" pulses and check A4M (C1C3). Change terminator if necessary. Check output of PA for pulses (A4P) and the look of them.

A4M	_____
Term	_____
A4P	_____
A4P	_____

C. Power Clear Pulses

1. Supply power clear pulses. Check neg amplitude at A3U (C1C4). Change terminator only if really bad pulse shape

A3U	_____ -V
-----	----------

2. Check pos. amplitude at A19R (C1C5). Change terminator if $> 2.7V$

A19R	_____ +V
Term	_____

3. Check that clear window pulses occur at A4W via B5P and B5M (WD2)

A4W	_____ 1
B5P	_____ +V
B5N	_____ -V

4. Check that clr status flop pulse exists at A2J (C1B4) Check terminator at _____

A2J	_____ +V
Term	_____

DRAWN
P.J. Priest 2/28/64

CHECKED
H. Kleanth 3/9/64

ENG
JCA



TITLE
CHECKOUT PROCEDURE

THIS SCHEMATIC IS FURNISHED ONLY FOR TEST & MAINTAINANCE PURPOSES. THE CIRCUITS ARE PROPRIETARY IN NATURE & SHOULD BE TREATED ACCORDINGLY.

App'v

NOV 4 1964

ECO. NO.
REV. LTR.

DWG NO
A-550-0-13

REV. LTR.

A

SHEET 11 OF 34

CODE
CP

IV. SELECTION CONTROL

- A. Supply power clear pulses and MMSE. Set delay times to "Fast".
- B. By changing bits 2, 3, 4, 5 of the "Test Accumulator" switches to one, the flops U4, U3, U2, U1 (in that order) will be set via the in gates and cleared by power clear at

A7R. (C1D1)

R(Y)F

R(Z)F

- C. Check both sides of each flop for rise time (0.2µs rise) and fall time.

(T)

(W)

Continue to sync on buss.

(M)

(N)

(J)

(L)

- D. Insert load plug (ten 100Ω resistors to -15) in B3 or B4 or turn selection switch on drive from point to point as check proceeds and check all decoder outputs by going through all the numbers 0-10. Check that each decoder output "waggles" with the correct number in the "AC", by looking at B4 X thru B4N.

- D _____
- 1 _____
- 2 _____
- 3 _____
- 4 _____
- 5 _____
- 6 _____
- 7 _____
- 8 _____
- 9 _____
- 10 _____

DRAWN
P.J. Priest : 2/28/64

CHECKED
[Signature] 3/9/64

ENG
[Signature]



EQUIPMENT CORPORATION
MAYNARD, MASSACHUSETTS

TITLE

CHECKOUT PROCEDURE

THIS SCHEMATIC IS FURNISHED ONLY FOR TEST & MAINTAINANCE PURPOSES. THE CIRCUITS ARE PROPRIETARY IN NATURE & SHOULD BE TREATED ACCORDINGLY.

APPV

NOV 4 1964

ECO. NO.
REV. LTR.

DWG NO
A-550-0-13

REV. LTR.
A

SHEET 12 OF 34

CODE
CP

V. MODE AND MOTION CONTROL

A. Supply power clear pulses in addition to MMLC.
Set delays to "FAST."

B. Mode

1. By setting test accumulator switch bits 15,16,17 up each "M" flop will be set by MMLC and cleared by power clear at A9R (C1C7). Check all rise and fall times and that correct switch runs correct flop.

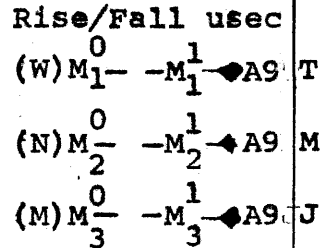

Continue to sync on buss pulse.

- C. 2. Check all 8 decoder for rise and fall by setting all modes in turn. "GO" must be one (bit 12=1) for this test. Temporarily ground A14P to simulate this. Check that outputs disappear when GO=zero.
3. Check the outputs of the inverters at C1B8 which supply the negative levels for assertion when needed.

0	___
1	___
2	___
3	___
4	___
5	___
6	___
7	___

C. Motion Flops

1. Go Flop

(a) by setting Bit 12 the Go flip flop will be set by MMLC and cleared by power clear. Do it. Check Rise and Fall times of Go Flop₀ and of buffers at BlL



DRAWN P. J. Priest 2/28/64 CHECKED <i>H. Beaulieu</i> 3/9/64 ENG <i>J. C. D.</i>	digital EQUIPMENT CORPORATION MAYNARD, MASSACHUSETTS	TITLE <p style="text-align: center; font-weight: bold;">CHECKOUT PROCEDURE</p>
THIS SCHEMATIC IS FURNISHED ONLY FOR TEST & MAINTAINANCE PURPOSES. THE CIRCUITS ARE PROPRIETARY IN NATURE & SHOULD BE TREATED ACCORDINGLY.		DWG NO <p style="text-align: center; font-weight: bold;">A-550-0-13</p> SHEET 13 OF 34
NOV 4 1964		REV. LTR. ECO. NO. <p style="text-align: center; font-size: 2em; font-weight: bold;">A</p> CODE CP

(b) Check status Bit at tester jack for neg B1L-R B1N-R
 when GO = one via inverter at B13Z (2C2A7) F F
 (right after MMLC pulse). Ignore rise time.

A14P
 R
 F

V.C.1. (c) Turn "Run" Switch off on panel and observe that
 GO flop is held=zero by inverter at A14U (ClC7).
 Turn "Run" Switch back on.

(d) Turn off power clears and set bit 12 switches on
 tester to supply a complementing level to Bit 12.

Continue to sync on buss. Observe that GO flip
 flop changes start on each MMLC pulse B5P

(e) Check that clear window pulses at B3P (WD1)
 occur at transition of GO to "0". A4W

2. Rev Flop

(a) Turn power clears back on. By setting Bit 13 0 1
 switch and Bit 12 the REV flop will be set by R
 MMLC and cleared by power clear. Check rise & F
 fall times of Flop. (ClC6) and of buffers at
 B13F and B16T. (200 ns max)

1
 0
 Rev ← Rev →
 A19V A19T

B13F R
 F
 B16T R
 F

DRAWN
 P.J. Priest 2/28/64
 CHECKED
[Signature] 3/9/64
 ENG
[Signature]

digital
 EQUIPMENT
 CORPORATION
 MAYNARD MASSACHUSETTS

TITLE
 CHECKOUT PROCEDURE

THIS SCHEMATIC IS FURNISHED ONLY FOR TEST
 & MAINTAINANCE PURPOSES. THE CIRCUITS ARE
 PROPRIETARY IN NATURE & SHOULD BE TREATED
 ACCORDINGLY.

APP'V

NOV 4 1964

ECO NO.
 REV. LTR.

DWG NO
 A-550-0-13
 REV. LTR.
 A
 SHEET 14 OF 34
 CODE
 CP

(b) Check status bit (at tester) for neg when Rev=1. via inv at B13R (C2A7). Ignore rise time problems

(c) Turn "Power Clear" off. Turn off bit 12 to clear GO. Observe that rev flip flop goes not change when Bit 13 switch is moved.

V.C.2. (d) Turn on Bit 12, change Rev to opposite state with Bit 13 and turn 12 back off. Observe that Rev still doesn't budge when Bit 13 switch is moved.

3. DELAYS

(a) Set TESTER TO "SLOW" (2 sec per cycle). Switch Bit 12 transfer switch so that it is supplied from the complementing flip flop. Supply MMLC pulses. GO Flop should alternately set and clear. (Rise time was previously checked).

SYNC ON BUSS

(b) Set START Delay to 150 MS (A12U) (C1A7). Check that it fires upon transition of GO to a "one". A12U _____

(c) Check output of DIP NOR at A16H. A16H _____

(d) Set Tester as in (a) but transfer bit 13 to the complementing line and bit 12 to the test switches. Set test switch 12 go "1" so REV will alternately set and clear at the slow rate.

()

DRAWN P.J. Priest 2/28/64	 EQUIPMENT CORPORATION <small>MAYNARD, MASSACHUSETTS</small>	TITLE <h2 style="text-align: center;">CHECKOUT PROCEDURE</h2>	
CHECKED <i>M. A. Beault</i> 3/9/64		DWG. NO. <h3 style="text-align: center;">A-550-0-13</h3>	
ENG <i>ZCA</i>			
NOV 4 1964		SHEET 15 OF 34	CODE CP

THIS SCHEMATIC IS FURNISHED ONLY FOR TEST & MAINTAINANCE PURPOSES. THE CIRCUITS ARE PROPRIETARY IN NATURE & SHOULD BE TREATED ACCORDINGLY.

APPV.

ECO. NO.
LTR.

(e) TURN AROUND Delay should be fired at both transitions of REV (at every pulse on the bus). Set it to 250MS., ALLU (C1A6)

(f) Check output of DIP NOR AT A16H check rise and fall time because it's used to generate a pulse. risetime / Fall risetime / Fall

(g) Similarly check DIP at B16F (C1A6)

D. Drive operation

(a) Load a (SFRATC+1) tape on drive. Generate MMSE select it. Generate MMLC and set TEST SW 12 ()=1 and 13 to the complementing flop. Drive should run alternately back and forth. Check that direction of motion agrees with status indication. Check for -15 at solenoid drivers Pin H (A13,B2) C1B6 during operation. If drive operation check out SD's and wiring (C1B6). B2E A13E

(b) Marginal Check -15 and +10 to decoder to drives to check selection and motion relays operation. Should work at -15MC least to -11 volts. -15 margins on panel B + 10 on Panel A. What failed?

(c) Remove tape (or let reels spin) for next few sections.

(d) Check enable level due to incorrect selection.

DRAWN P.J. Priest 2/28/64		 digital EQUIPMENT CORPORATION MAYNARD, MASSACHUSETTS	TITLE	
CHECKED <i>M. A. ...</i> 3/9/64			CHECKOUT PROCEDURE	
ENG <i>ZCA</i>				
THIS SCHEMATIC IS FURNISHED ONLY FOR TEST & MAINTAINANCE PURPOSES. THE CIRCUITS ARE PROPRIETARY IN NATURE & SHOULD BE TREATED ACCORDINGLY.		APPV	DWG NO	
NOV 4 1964		ECO. NO.	A-550-0-13	
		REV. LTR.	SHEET 16 OF 34	
			REV. LTR. A	
			CODE CP	

E. WINDOW Clear

Check clr Window pulses due to both transitions Start _____
of DIP at A4U and Y. See output at A4W. (WD3)

Change sync to DIP output (A16H going to ground) _____
to see pulse due to transition at trailing edge. end _____

VI. WRTM MODE

A. Clock Timing Pulses

Set Test Switches to search mode (MMLC and 15-17 = 001).

1. Close Back panel switch to close RELTM relay. Back panel light near switch should light. Red light on drive(s) should light. UP = ON

Relay should close. Check for ground at A16K _____
(C2C2) and neg at B7L and B7W. _____ B7L

See that all three points reverse when switch is _____
turned back off. _____ B7W

Leave RELTM switch on for remainder of procedure
until test tape is mounted for tape operation.

Sync on Clock Pulses.

2. Check Clock output at C17F (TMA1) (positive pulses). _____ volts
Terminate to 2.7 volts or less at A25J if necessary. _____ Term
Note term size if new. Set Clock to 8-1/3 psec for _____ size
new. Turn off RELTM sw and check that clock stops. _____ Stop?

DRAWN P.J. Priest 2/28/64

CHECKED *M. B. Bault* 3/7/64
ENG *JCA*

digital
EQUIPMENT CORPORATION
MAYNARD, MASSACHUSETTS

TITLE

CHECKOUT PROCEDURE

THIS SCHEMATIC IS FURNISHED ONLY FOR TEST & MAINTAINANCE PURPOSES. THE CIRCUITS ARE PROPRIETARY IN NATURE & SHOULD BE TREATED ACCORDINGLY.

APPLY
ECO. NO.
REV. LTR.

NOV 4 1964

DWG NO
A-550-0-13
SHEET 17 OF 34

REV. LTR.
A
CODE
CP

3. (a) Using WRTM waveforms at TMC4 Check Clock Flip Flops.

R/F
 CK1' /
 CK2' /

(b) Check RECTM at C13T, S (TMC3). (Wiggle RELTM switch to make sure).

C13T

(c) Check TP1 and TP0 at C10P, W (TM34).
 Temporarily ground DIP \blacktriangleleft at C10Z and check that TP's disappear. Check at B9X and B6S and change terms if $>2.7V$.

C10P
 C10W
 C10W
 C10P

(d) Check for TP2A at C11E and C10H (TMA5). Set delay to 4.5 μs . Also look at and and change term if necessary at to reduce pulse to 2.7V. Check TP2 at C10H and at C20U change term if necessary to reduce pulse to 2.7 volts.

term
 de
 C11E
 C10H
 TP2A
 Term
 Term
 TP2A
 tem ohm
 TP2
 tem ohm

B. "EK"

1. Set drive number in test SWITCHES 2-5. Generate MMSE to select drive. Set UP WRTM MODE (15, 16, 17 of TEST SWITCHES = 111). Set bit 12 to complementing line. Generate MMLC at FAST rate to create an "alternating WRTM mode."

Sync again on bus pulses (MMLC)

(a) Check output of decoder at A10Z (C1B8) for proper alternation.

DRAWN
 P.J. Priest 2/28/64
 CHECKED
[Signature] 3/7/64
 ENG
[Signature]



TITLE
CHECKOUT PROCEDURE

THIS SCHEMATIC IS FURNISHED ONLY FOR TEST & MAINTAINANCE PURPOSES. THE CIRCUITS ARE PROPRIETARY IN NATURE & SHOULD BE TREATED ACCORDINGLY.

APP'V

NOV 4 1964

ECO. NO.
 REV. LTR.

DWG NO
 A-550-0-13

REV. LTR.
 A

SHEET 18 OF 34

CODE
 CP

(b) Check alternating output of WRTMR \blacklozenge at A17M - make sure phasing is correct - (C2C2), at A15R (C1B8), and at A17T (C2B3).

_____ A17T
 _____ B7M
 _____ A17R
 _____ B7W
 _____ B7K

(c) Change to WRT MODE (011) and check A17K (C2C2) and A17W for proper alternation. Also A17R.

(d) **SYNC ON WRTMR TRANSITIONS** and check preset pulses at B22Z. (WC2) (Also sync on B23X & Flip RELTM Switch & look for pulses). (Blk MK should not be present since window has been cleared.) BM

_____ B22Z

(e) **SYNC ON TPO's at C10W** and check TPO's at B22X.

2. Change from complementing mode to continuous WRTMR mode by selecting TEST bit 12 switch and making it=one.

(a) Find EK6 waveform on print (WB7) \blacklozenge EK6' \blacklozenge
 Check carefully the risetime, and duration. R/F _____
 If necessary from now on, jiggle RELTM Toggle which should preset the EK if it has been disturbed.

(b) Check same EK6' waveform at A17S and Z. A17S _____
 (Note notch at Z due to TP2's. (C2C3) A17Z _____

SYNC ON leading (NEG) edge WAVEFORM AT A17S for rest of procedure.

DRAWN
P.J. Priest 2/28/64
 CHECKED
H. Beaulieu 3/9/64
 ENG *JCA*



TITLE
CHECKOUT PROCEDURE

THIS SCHEMATIC IS FURNISHED ONLY FOR TEST & MAINTAINANCE PURPOSES. THE CIRCUITS ARE PROPRIETARY IN NATURE & SHOULD BE TREATED ACCORDINGLY.

APP.V
 ECO NO.
 REV. LTR

NOV 4 1964

DWG NO A-550-0-13
 SHEET 19 OF 34
 REV. LTR. A
 CODE CP

change term if necessary at _____ to
 reduce pulse to 2.7V
 Check TP2 at C10H and at C20U
 change term if necessary to reduce
 pulse to 2.7 volts.

TP2A _____ ohm
 tem _____ ohm
 TP2 _____
 tem _____ ohm

B. "EK"

1. Set drive number in test Switches 2-5.
 Generate MMSE to select drive. Set up WRTM
 MODE (15,16,17 of TEST SWITCHES = 111).
 Set bit 12 to complementing line. Generate
 MMLC at FAST rate to create an "alternating
 WRTM mode."

Sync again on bus pulses (MMLC)

- (a) Check output of decoder at A10Z (C1B8)
 for proper alternation.
- (b) Check alternating output of WRTMR \blacktriangleleft
 at A17M, make sure passing is correct.
 (C2C2), at A15R (C1B8), and at A17T (C2B3)
 (C2B3)

_____ A17T
 _____ A17M
 _____ A17R
 _____ A17W
 _____ A17K

- (c) Change to WRT MODE (011) and check
 A17K (C2C2) and A17W for proper
 alternation. Also A17R.

DRAWN
P.J. PRIEST 2/28/64

CHECKED
[Signature] 3/7/64

ENG
[Signature]



TITLE
CHECKOUT PROCEDURE

THIS SCHEMATIC IS FURNISHED ONLY FOR TEST & MAINTENANCE PURPOSES. THE CIRCUITS ARE PROPRIETARY IN NATURE & SHOULD BE TREATED ACCORDINGLY.

NOV 4 1964

ECO NO.
 REV. LTR.

DWG NO
A-550-0-13

REV. LTR.
A

SHEET 20 OF 34

CODE
 CP

(d) **SYNC ON WRTMR TRANSITIONS** and check preset pulses at B22Z. (WC2)
 (Blk MK should not be present since window has been cleared)

B22Z

BM

(e) **SYNC on TPO's at C10W** and check

TPO's at B22X.

2. Change from complementing mode to continuous WRTMR mode by selecting TEST bit 12 switch and making it = one.

(a) Find EK6 waveform on print. (WB7)

EK6' 

Check carefully the risetime, and duration. If necessary from now on, jiggle RELTM Toggle which should preset the EK if it has been disturbed.

R/F

(b) Check same EK6  waveform at A17S and Z.
 (Note notch at Z due to TP2's (C2C3))

A17S

A17Z

SYNC ON leading (NEG) edge WAVEFORM AT A17S for rest of procedure.

DRAWN
 P.J. Priest 2/28/64

CHECKED
[Signature] 3/11/64
 ENG
[Signature]

digital
 EQUIPMENT CORPORATION
 MAYNARD, MASSACHUSETTS

TITLE

CHECKOUT PROCEDURE

THIS SCHEMATIC IS FURNISHED ONLY FOR TEST & MAINTAINANCE PURPOSES. THE CIRCUITS ARE PROPRIETARY IN NATURE & SHOULD BE TREATED ACCORDINGLY.

APP. V.

ECO NO.
 REV. LTR.

NOV 4 1964

DWG NO

A-550-0-13

REV. LTR.

A

SHEET

21

OF

34

CODE CP

VII. C. WREN FLOP

1. Change back to fast complementing GO mode in WRM mode so as to alternately clear and set WREN via A17Z and A17W. (C2C3)
 - (a) Set Bit 12 to complementing flop.
 - (b) Set 15,16,17 = 111, Bit 13=0 (FWD)
 - (c) Generate MMLC
 - (d) Disconnect one end error diode at B115 is not already done.
 - (e) Ground (CLIP LEAD) at AZZN to prevent false unable errors from clearing WREN.

2. Check WREN RISE AND FALL TIMES SYNC ON ITSELF

3. SYNC ON BUSS AGAIN

Check that RDF pulses appear at A23W (C2C3) (via A24Z) (C2B4) when and only when WRTMR exists. A23W _____

4. Check that M Break pulses occur at output of A2W (C2A4) for each RDF and that they also occur at tester MB jack. A2W _____
tester _____

5. Check write interlocking

- (a) Wren level at B13 U,W,S, (C1A5) (check rise & fall time carefully)

To see rise times of WREN place on Slow MMLC comp bit up and probe on A19Z the other on B13U when is 1, other is negative.

R F

DRAWN P.J. Priest 2/28/64 CHECKED <i>[Signature]</i> 3/7/68 ENG <i>[Signature]</i>	 digital EQUIPMENT CORPORATION MAYNARD, MASSACHUSETTS	TITLE <p style="text-align: center;">CHECKOUT PROCEDURE</p>
THIS SCHEMATIC IS FURNISHED ONLY FOR TEST & MAINTAINANCE PURPOSES. THE CIRCUITS ARE PROPRIETARY IN NATURE & SHOULD BE TREATED ACCORDINGLY.		Appv ECO. NO. REV. LTR.
NOV 4 1964		DWG NO <p style="text-align: center;">A-550-0-13</p> SHEET 22 OF 34
		REV. LTR. <p style="font-size: 2em; font-weight: bold;">A</p> CODE CP

(b) Check neg level at C18,19,20 L via selection and write Lock Switch on drive. (C1A4) Check that ground occurs always on deselecting or WRITE LOCK SWITCH OFF. Repeat for each drive in system.

C20L _____
C20L _____

(c) Check neg level at C24, C25 L via RELTM relay C23S, E. (C1A2)

(d) Turn off RELTM and check continuity between C24L and ground.

(e) Set drive switch to write lock, and observe outputs of C9V and C9Z (C2C7). They should go NEG when WREN and positive otherwise. Remove clip on unable at A22N. No unable failures should occur.

C9V _____
C9Z _____

(f) Check Wren Transitions at B16, V,X,Z (C2A2);

A21S (TMA5); B8S, P (TMA6); B8F, L (TMC5)

(g) B10S, K (TMA7) Neg transitions must be fast

_____ ns
_____ ns

(h) Check SRWB (TEST SW 13 = 0 FOR REV⁰ level) Pulse at B10P, B13L, (TMA7) due to wren' transition.

B10P _____
B13L _____
TERM _____ 0
()

(i) Similarly check for SLWB (TS 13 - 1) at B10H, B13J. (TMA7) Check terminators

B10H _____ 0
B13J _____
TERM _____
()

(j) Slowly comp wren F.F. Rev bit=0. See that B10T is neg. Look for Single pulse at B10P for WREN transition from ground to neg for wren a "1"

DRAWN
P.J. Priest 2/28/64
CHECKED
[Signature] 3/7/64
ENG
[Signature]



TITLE
CHECKOUT PROCEDURE

THIS SCHEMATIC IS FURNISHED ONLY FOR TEST & MAINTAINANCE PURPOSES. THE CIRCUITS ARE PROPRIETARY IN NATURE & SHOULD BE TREATED ACCORDINGLY.

APPV
ECO. NO.
REV. LTR.

NOV 4 1964

DWG NO
A-550-0-13
SHEET 23 OF 34
REV. LTR. **A**
CODE CP

VI. D. 3. (b)

(2) CPW at B11X
M
 Must disappear if WRTM goes
 (change to 011 = WRT temporarily)

B11X _____

TERM at 0

(3) TS13 (REV) = 0; MODE (011)
 FIND SR. at B6P (TMB6)
 must disappear in WRT (011)
 mode, with write lock switch in
 read only, and also with REV = 1.

B6P _____
 $\overline{B6P}$ _____ WR LOCK
 $\overline{B6P}$ _____ REV = 1

(4) TSB (REV) = 1; mode 010 Find
 SL at B6W (TMC6) - must disappear
 in WRT with write end switch
 in read only. And also REV=0.

B6W _____
 $\overline{B6W}$ _____
 $\overline{B6W}$ _____

(5) Change Search Mode (000)
 Find MMSR SR at
 B6P (TMB6) due to
 B9T (TMB4) and B7Z
 NEG
 Check for Disappearance
 when not search mode

B6P _____
 B9T _____
 B7Z _____

000

(c) TP2

(1) Ground LOCK at B24X (WA5) tempor-
 arily and see 0- \blacklozenge SR at B11H (TMA5)
 and CPSR at B12H (1 usec pos) (TMA6)
 see waveforms on print

B11H _____
 TERM _____ 0
 B12H _____
 TERM _____ 0

DRAWN
 P.J. Priest 2/28/64
 CHECKED
M. Rhoadt 3/9/64
 ENG
2CS



TITLE

CHECKOUT PROCEDURE

THIS SCHEMATIC IS FURNISHED ONLY FOR TEST
 & MAINTAINANCE PURPOSES. THE CIRCUITS ARE
 PROPRIETARY IN NATURE & SHOULD BE TREATED
 ACCORDINGLY.

APPV

ECO. NO.
 REV LTR.

NOV 4 1964

DWG NO

A-550-0-13

REV. LTR.

A

SHEET

24 OF 34

CODE
 CP

- D. 3. (c) (2) In WRTM MODE (111 & GO) RDF pulses at B11S (TMA6) should cause interchange pulses at B11P, (TMA6) every 200 μ s. if the LOCK jumper is removed B11P from B24X. They should disappear when LOCK short is replaced on B24X. Leave it off when due. Check size of RDF pulses at B11S and terminate if needed to reduce pulse to 2.7 volts
- B11S _____
TERM _____ 0
- (3) In WRTM MODE produce FINAL mark by grounding B24T (WA6) B11P should show interchange pulses via B9H and B9F. (TMA5) Remove FINAL ground; interchanges should disappear. Remove
- B9H _____
 $\bar{B}9\bar{H}$ _____
- (4) Ground B24Z (WA6) to produce RBF pulses by generating prefinal change mode to WRT (011) (TMA6). RBFS should appear at B11M (011) (TMA6) via A23P (C2B1) Terminate if necessary. Check output of interchange at B11P
- B11M _____
TERM _____
B11P _____

DRAWN
P.J. Priest 2/28/64

CHECKED
N. K. Heault 3/9/64

ENG
J. C. A.

digital
EQUIPMENT CORPORATION
MAYNARD, MASSACHUSETTS

TITLE

CHECKOUT PROCEDURE

THIS SCHEMATIC IS FURNISHED ONLY FOR TEST & MAINTENANCE PURPOSES. THE CIRCUITS ARE PROPRIETARY IN NATURE & SHOULD BE TREATED ACCORDINGLY.

APPV

NOV 4 1964

ECO. NO.
REV. LTR.

DWG NO

A-550-0-13

REV. LTR.

A

SHEET 25 OF 34

CODE
CP

IX. INFORMATION BUFFER & SHIFT REGISTER

A., SET UP

Select tape unit and load WRTM status. (Repeat slowly MMLC then MMSE). Put the tape control in RELTM mode via the Toggle switch on the back panel. Tape need not be mounted on drive.

INAL Then check at C2 - C7Y for MMWR pulse. Change terminator only if pulse amplitude is greater than 3 volts.

MMWR _____

Term _____

B. SYNC

Synchronize scope on EK₆¹. This syncing will be maintained throughout the next portion of the procedure. Use the negative leading edge of the square waveform at A17Z to avoid loading the EK₆ flop.

It is convenient to use a dual-trace scope from here on and display the waveform which is present at A17Z (see next paragraph for picture) throughout the next part of the procedure along with the other waveforms which will be viewed.

DRAWN P.J. Priest 2/28/64 CHECKED <i>[Signature]</i> 3/1/64 ENG.	 digital EQUIPMENT CORPORATION <small>MAYNARD, MASSACHUSETTS</small>	TITLE <p style="text-align: center;">CHECKOUT PROCEDURE</p>
THIS SCHEMATIC IS FURNISHED ONLY FOR TEST & MAINTAINANCE PURPOSES. THE CIRCUITS ARE PROPRIETARY IN NATURE & SHOULD BE TREATED ACCORDINGLY.		APP'Y ECO. NO. REV. LTR.
NOV 4 1964		DWG NO <p style="text-align: center;">A-550-0-13</p> SHEET 26 OF 34
		REV. LTR. <p style="font-size: 2em; font-weight: bold;">A</p> CODE CP

C. DATA FLAG

C2B4 (1) Check existence of MB pulses (Break Request pulses) from pulse generator at (). These pulses should cause the delay in tester to operate and return MMWR pulses to C2=C7Y, via tester jack, cable, plug, and taper pin block. MMWR _____

INAL Change terminator on chocolate block only if greater than 3 volts.

(2) Check MMWR pulse into PA at A2M. Do not change terminator unless pulse is terrible. A2M _____
Term _____

C2B2? (3) Check Clr DF/BF pulses (pos) at A2R. A2R _____

(4) Observe Data Flag Flip-Flop at A19X, A19Z R F
A19X //

A19Z /

DRAWN P.J. Priest 2/28/64
CHECKED *[Signature]* 3/9/64
ENG

digital
EQUIPMENT CORPORATION
MAYNARD, MASSACHUSETTS

TITLE
CHECKOUT PROCEDURE

THIS SCHEMATIC IS FURNISHED ONLY FOR TEST & MAINTAINANCE PURPOSES. THE CIRCUITS ARE PROPRIETARY IN NATURE & SHOULD BE TREATED ACCORDINGLY.

APP'Y

NOV 4 1964

ECO. NO.
REV. LTR.

DWG NO
A-550-0-13

REV. LTR.
A

SHEET 27 OF 34

CODE
CP

D. MMIOB

(Refer to sketch of IOB waveforms).
 With trace of EK6 flop on screen, (if used) use second trace to observe output of each MMIOB bit immediately prior to the interchange pulse.

MMIOB OUTPUTS TO ACCUMULATORS:

0	/	/	9
1	/	/	10
2	//	/	11
3	/	/	12
4	/	/	13
5	/	/	14
6	/	???	15
7	/	/	16
8	/	/	17

Ignore other parts of the waveform. With corresponding "Test ACC" switch equal to zero ("0") (down), the MMIOB bit should be ground on the bus. With switch = "1" (up) the bit should be -3 v. prior to interchg.

Note: Bits 2-4; 12-17 will affect mode and selection - turn off MMLC and MMSE pulses when checking these bits.

E. SHIFT REGISTER

With first trace and syncing as before observe the output of each SR bit immediately following the interchange pulse. Ignore other parts of the waveform. With corresponding "ACC" switch = zero (down) the MMSR bit output should be -3 on the appropriate pins of C2-C7. Note: As in bits 2-4, 12-17 will affect mode and selection, so turn off MMSE, MMLC.

DRAWN
 P.J. Priest 2/28/64
 CHECKED
J. Keault 3/9/64
 ENG



TITLE
 CHECKOUT PROCEDURE

THIS SCHEMATIC IS FURNISHED ONLY FOR TEST & MAINTAINANCE PURPOSES. THE CIRCUITS ARE PROPRIETARY IN NATURE & SHOULD BE TREATED ACCORDINGLY.

Appv

NOV 4 1964

ECO. NO.
 REV. LTR.

DWG NO
 A-550-0-13
 SHEET 28 OF 34

REV. LTR.
 A
 CODE
 CP

F. SHIFTING IN TOTAL.

Same syncing as before but with one full cycle of

EK6 on screen: Observe SR bit 5, (11) (17) (FWD)

0, (6), (12) (REV).

The switches should affect the waveforms at times

indicated in drawing.

DRAWN
P.J. Priest 2/28/64
CHECKED
M. O'Connell 3/9/64
ENG

digital
EQUIPMENT
CORPORATION
MAYNARD, MASSACHUSETTS

TITLE
CHECKOUT PROCEDURE

THIS DRAWING IS FURNISHED ONLY FOR TEST PURPOSES. THE CIRCUITS ARE EXPERIMENTAL IN NATURE & SHOULD BE TREATED ACCORDINGLY.

APPV

NOV 4 1964

ECO. NO.
REV. LTR.

DWG NO
A-550-0-13

REV. LTR.

A

SHEET 29 OF 34

CODE
CP

XI.

C. MARK TRACK AND MARK ERROR FUNCTION

(Rock in Read Mode 2 octal)

WB5

(1) Find "OR" off all marks at B19T and inverse at B20U

Sync on 13E. Notice that exactly two marks are missing (future mode change)

(2) Find EK1 waveform at B20R. Notice off-set.

WC3

At B20R notice offset

(a) Check preset pulses at B22-7

(3) Find \oplus at B15W notice narrow guard (if CLR

window OK)
Missing RBM - G.

(4) Find window open at B15V

WD1

(a) Check clear window pulses at B5P due to guard and mark

(5) Find BMF level at B15U.

(a) Check exact transition times at BM & guard)

(b) Check

DRAWN
P.J. Priest 2/28/64

CHECKED
M. R. Leach 3/9/64

ENG

digital
EQUIPMENT
CORPORATION
MAYNARD, MASSACHUSETTS

TITLE
CHECKOUT PROCEDURE

THIS SCHEMATIC IS FURNISHED ONLY FOR TEST & MAINTENANCE PURPOSES. THE CIRCUITS ARE PROPRIETARY IN NATURE & SHOULD BE TREATED ACCORDINGLY.

APPV

NOV 4 1964

ECO. NO.
REV. LTR.

DWG NO
A-550-0-13

REV. LTR.

A

SHEET 30 OF 34

CODE
CP

IX. INFORMATION BUFFER & SHIFT REGISTER

A. SET UP

Select tape unit and load WRTM status. (Repeat slowly MMSE then MMLC). Put the tape control in RELTM mode via the Toggle switch on the back panel. Tape need not be mounted on drive.

B. SYNC

Synchronize scope on EK_6^1 . This syncing will be maintained throughout the next portion of the procedure. Use the negative leading edge of the square waveform at A17Z to avoid loading the EK_6 flop.

It is convenient to use a dual-trace scope from here on and display the waveform which is present at A17Z (see illustration _____) throughout the next part of the procedure along with the other waveforms which will be viewed.

NOTE: At this point, experience indicates it would be a good idea to resolder all joints on C2-C7 (Units plugged in).

C. DATA FLAG

(1) Check existence of MB pulses (Break Request pulses) from pulse generator at (C2A4). These pulses should cause the delay in tester to operate and return MMWR pulses to C2-C7Y, via tester jack, cable, plug, and taper pin block. MMWR _____

Change terminator only if greater than 3 volts.

DRAWN P.J. Priest 2/28/64 CHECKED <i>[Signature]</i> 3/4/64 ENG	 digital EQUIPMENT CORPORATION MAYNARD, MASSACHUSETTS	TITLE <p style="text-align: center;">CHECKOUT PROCEDURE</p>			
THIS SCHEMATIC IS FURNISHED ONLY FOR TEST & MAINTAINANCE PURPOSES. THE CIRCUITS ARE PROPRIETARY IN NATURE & SHOULD BE TREATED ACCORDINGLY.		APPV			
NOV 4 1964		ECO. NO.	DWG NO <p style="text-align: center;">A-550-0-13</p>	REV. LTR.	REV. LTR. <p style="font-size: 2em; text-align: center;">A</p>
		REV. LTR.	SHEET 31 OF 34		CODE CP

IX. C. (2) Check MMWR pulse into PA at A2M (C1B4). Do not change terminator unless pulse is terrible.

A2M _____

Term _____

(3) Switch briefly to supply MMRD from tester and check A2S and terminate. Check A2R for output.

A2S _____

Term _____

A2R _____ (+V)

Term _____

(4) Check clr DF/BF pulses (pos) at A2R (C1B4). Term if necessary.

R F

A19X /

A19X /

(5) Observe Data Flag Flip-flop at A19X, A19Z. It should be set by RDFs via A14L (C2B6) and cleared by clr DF/BF from MMWR.

D. MMIOB

(Refer to sketch of IOB waveforms). With trace of EK6 flop on screen (if used), use second trace to observe output of each MMIOB bit immediately prior to the interchange pulse. Ignore other parts of the waveform. With corresponding "Test ACC" switch equal to zero ("0") (Down), the MMIOB bit should be ground on the bus. With switch="1" (up) the bit should be -3 V prior to interchg.

MMIOB OUTPUTS TO ACCUMULATOR:

0	/	/	9
1	/	/	10
2	/	/	11
3	/	/	12
4	/	/	13
5	/	/	14
6	/	/	15
7	/	/	16
8	/	/	17

E. SHIFT REGISTER

With first trace and syncing as before observe the output of each SR bit immediately following the interchange pulse. Ignore other parts of the waveform. With corresponding "ACC" switch=zero (down) the MMSR bit output should be -3 on the appropriate pins of C2-C7. Note: As in bits 2,-4, 12-17 will affect mode and selection, so turn off MMSE, MMLC.

DRAWN P.J. Priest 2/28/64
 CHECKED *[Signature]* 3/7/64
 ENG



TITLE
 CHECKOUT PROCEDURE

THIS SCHEMATIC IS FURNISHED ONLY FOR TEST & MAINTAINANCE PURPOSES. THE CIRCUITS ARE PROPRIETARY IN NATURE & SHOULD BE TREATED ACCORDINGLY.

APPV

NOV 4 1964

ECO. NO.
 REV. LTR.

DWG NO
 A-550-0-13

REV. LTR.
 A

SHEET 32 OF 34

CODE CP

F. WRITING WAVEFORMS AT HEADS (WRM)

G. SHIFTING IN TOTAL

Same syncing as before but with one full cycle of EK6

on screen: Observe SR bit 5, (11) (17) (FWD)

0, (6), (12) (REV).

The switches should affect the waveforms at times indicated in drawing.

X. Set, up to read, test read signal, alignment of Amps, rocker, timing pulses WINDOW Read in waveforms.

XI.

A. WINDOW OUT

B. + MARK SYNC OUT

DRAWN
P.J. Priest 2/28/64

CHECKED
H. A. Heald 3/9/64
ENG

digital
EQUIPMENT
CORPORATION
MAYNARD, MASSACHUSETTS

TITLE

CHECKOUT PROCEDURE

THIS SCHEMATIC IS FURNISHED ONLY FOR TEST
& MAINTAINANCE PURPOSES. THE CIRCUITS ARE
PROPRIETARY IN NATURE & SHOULD BE TREATED
ACCORDINGLY.

APPV

NOV 4 1964

ECO. NO.
REV. LTR.

DWG NO

A-550-0-13

REV. LTR.

A

SHEET 33 OF 34

CODE
CP

TEST ACCUMULATOR SWITCHES

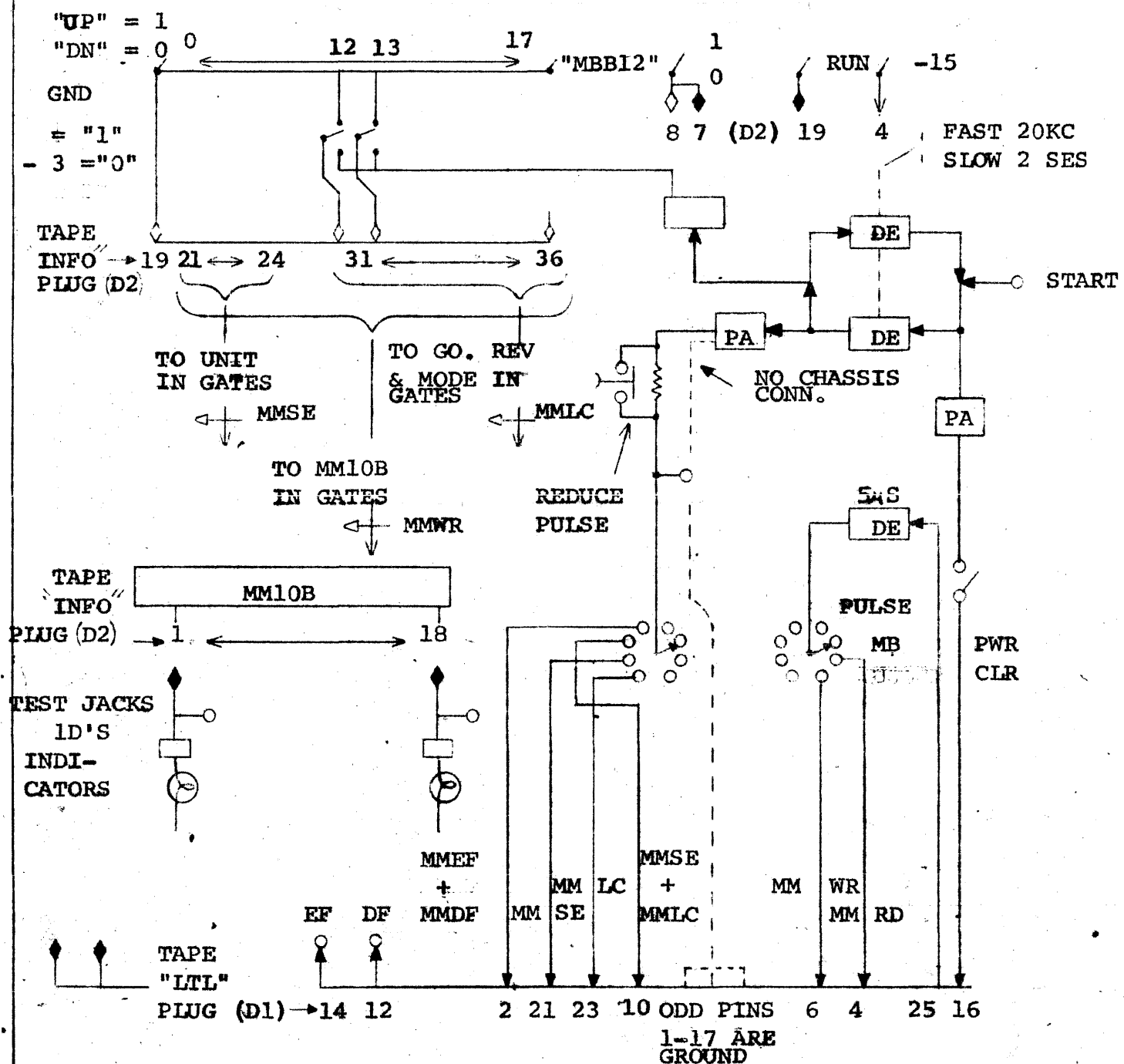

TITLE		CHECKOUT PROCEDURE		REV. LTR.	CODE
		DWG NO	A-550-0-13	A	CP
digital EQUIPMENT CORPORATION MAYNARD, MASSACHUSETTS		APP'V	ECO. NO.	SHEET	OF
		THIS SCHEMATIC IS FURNISHED ONLY FOR TEST & MAINTENANCE PURPOSES. THE CIRCUITS ARE PROPRIETARY IN NATURE & SHOULD BE TREATED ACCORDINGLY.	REV. LTR.	34	34
DRAWN Elaine Massarelli 3/4/64		NOV 4 1964			
CHECKED <i>Elaine Massarelli</i> 3/9/64					
ENG					

JACK <input checked="" type="checkbox"/>	PLUG <input type="checkbox"/>	LOCATION, LENGTH, ROUTE
FEMALE <input checked="" type="checkbox"/>	MALE <input type="checkbox"/>	

COLOR	PIN	PIN	NAME	COLOR	PIN	PIN	NAME
WHITE	2H08X-F1	1	MMIO-0	WHITE	2H03H-F1	26	ACB 7
	2H09X-F1	2	MMIO-1		2H03J-F1	27	ACB 8
	2H10X-F1	3	MMIO-2		2H03K-F1	28	ACB 9
	2H11X-F1	4	MMIO-3		2H03L-F1	29	ACB 10
	2H12X-F1	5	MMIO-4		2H03M-F1	30	ACB 11
	2H13X-F1	6	MMIO-5		2H03N-F1	31	ACB 12
	2H14X-F1	7	MMIO-6		2H03P-F1	32	ACB 13
	2H15X-F1	8	MMIO-7		2H03R-F1	33	ACB 14
	2H16X-F1	9	MMIO-8		2H03S-F1	34	ACB 15
	2H17X-F1	10	MMIO-9		2H03T-F1	35	ACB 16
	2H18X-F1	11	MMIO-10		2H03U-F1	36	ACB 17
	2H19X-F1	12	MMIO-11		2H03V-F1	37	MMB 12
	2H20X-F1	13	MMIO-12	WHITE	2H03W-F1	38	MMB 12
	2H21X-F1	14	MMIO-13			39	
	2H22X-F1	15	MMIO-14			40	
	2H23X-F1	16	MMIO-15			41	
	2H24X-F1	17	MMIO-16			42	
	2H25X-F1	18	MMIO-17			43	
	2H03A-F1	19	ACB 0			44	
	2H03B-F1	20	ACB 1			45	
	2H03C-F1	21	ACB 2			46	
	2H03D-F1	22	ACB 3			47	
	2H03E-F1	23	ACB 4			48	
	2H03F-F1	24	ACB 5			49	
WHITE	2H03G-F1	25	ACB 6	BLK	GND.	50	GND.

DRAWN
Lois Brown 7-3-63

CHECKED
[Signature] 7/7/63

ENG
[Signature]



50 PIN AMPHENOL

TITLE

TO INFO PLUG OF

550 M.T. CONTROL

REF: 550-01-00-03-00

THIS SCHEMATIC IS FURNISHED ONLY FOR TEST & MAINTENANCE PURPOSES. THE CIRCUITS ARE PROPRIETARY IN NATURE & SHOULD BE TREATED ACCORDINGLY.

NOV 4 1964

1-4-63-24-01
8-11-63
8-11-63
8-11-63

APPV
ECO NO.
REV. LTR.

DWG NO
A-550-01-00-04-00

REV. LTR.
B

SHEET OF

CODE
CL

COLOR	NAME	PIN	PIN	REMARKS
WHITE	BLK F'	2H09T-F1	2H07X-F2	
WHITE	BLK F'	2H07X-F1	2H05U-F2	
WHITE	ERR F'	2E10T-F1	2H07F-F2	
WHITE	DATA F'	2H07J-F1	2H05T-F2	
WHITE	DATA F	2H08T-F1	2H07J-F2	
GRAY	IOT 7502	2F18H-F1	2H08W-F1	
GRAY	IOT 7502	2F19H-F1	2H08S-F1	
GRAY	IOT 7601	2F19E-F1	2H07W-F2	

DRAWN
LOIS BROWN 7-3-63

CHECKED
[Signature] 11/1/64

ENG
[Signature]



GENERAL WIRING SHEET

TITLE
550 TAPE CONTROL:

WIRING IN REAL TIME
SECTION

<p>THIS SCHEMATIC IS FURNISHED ONLY FOR TEST & MAINTAINANCE PURPOSES. THE CIRCUITS ARE PROPRIETARY IN NATURE & SHOULD BE TREATED ACCORDINGLY.</p>											
				NOV 4 1964	APPV <i>[Signature]</i>	ECO. NO. REV. LTR.	DWG NO	REV. LTR.			
				B 11/1/64			A-550-01-00-05-00	B			
				A-4-00-24-01			SHEET	OF			
				B-DWG. NO. V145					CODE		
									W/L		

JACK <input checked="" type="checkbox"/>	PLUG <input type="checkbox"/>	LOCATION, LENGTH, ROUTE
FEMALE <input checked="" type="checkbox"/>	MALE <input type="checkbox"/>	

COLOR	PIN	PIN	NAME	COLOR	PIN	PIN	NAME
BLACK	GND	1	GND	WHITE	2H08T-F2	26	DATA F'
GRAY	2F18E-F1	2	IOT 7501		2H09T-F2	27	BLK F'
BLACK	GND	3	GND		2H10T-F2	28	ERR F'
GRAY	2H25S-F1	4	IOT 7502		2H11T-F2	29	OFF END
BLACK	GND	5	GND		2H12T-F2	30	MIS IND
GRAY	2F18K-F1	6	IOT 7504		2H13T-F2	31	REV.
BLACK	GND	7	GND		2H14T-F2	32	GO
GRAY	2H16S-F1	8	IOT 7602		2H15T-F2	33	MK TK ERR
BLACK	GND	9	GND	WHITE	2H16T-F2	34	UNABLE
GRAY	2F19K-F1	10	IOT 7604			35	
BLACK	GND	11	GND			36	
GRAY	2E24W	12	47K TO			37	
BLACK	GND	13	GND			38	
GRAY	2E24U	14	TERMINATORS			39	
BLACK	GND	15	GND			40	
GRAY	2H04B-F3	16	RTO PWR. CLR.			41	
BLACK	GND	17	GND			42	
BLACK	GND	18	GND			43	
GRAY	2H04F-F3	19	RTO BEGIN			44	
BLACK	GND	20	GND			45	
		21				46	
		22		RED	2H05Q	47	+10
		23				48	
		24		BLUE	2H06Q	49	-15
		25		BLACK	GND	50	GND

DRAWN
Lois Brown 7-8-63

CHECKED
M. A. Beault 7/9/63

ENG
J. P. Atwood



50 PIN AMPHENOL

TITLE
TO CONTROL PLUG
(550 M.T. CONTROL)

REF: 550-01-00-02-00

THIS SCHEMATIC IS FURNISHED ONLY FOR TEST & MAINTAINANCE PURPOSES. THE CIRCUITS ARE PROPRIETARY IN NATURE & SHOULD BE TREATED ACCORDINGLY.

NOV 4 1964

11-1-63

B-DWG NO. WAS

APPV

ECO. NO.

REV. LTR.

DWG NO
A-550-01-00-05-00

REV LTR.
B

SHEET 1 OF 1

CODE
CL